



REAL

ENTERPRISES
QUALITY FIRST
Since 1908



DENTAL

Instruments Catalogue





TABLE OF CONTENTS

01	Tooth Extracting Forceps		01-49
02	Root Elevators		50-70
03	Scalpel Handles, Handles, Mouth Mirrors Scalers, Explorer / Probes		71-85
04	Endodontic Condensers, Obturation Instruments Excavators, Explorer / Probes, Curette Sets		86-96
05	Amalgam Pluggers / Condensers, Burnishers		97-100
06	Wax Carvers, Carvers, Chisels		101-103
07	Compote Placement, Plastic Filling Instruments		104-107
08	Curettes, Gracey Curettes, Dental Products, Knives		108-117



TABLE OF CONTENTS

09	Wax Porcelain & Cement Instruments Wax & Modeling Instruments		118-121
10	Spatulas, Cement Spatulas		122-124
11	Files, Hoes, Knives, Wax & Plaster Knives, Crane Kaplan		125-128
12	Bone Curettes, Bone Files, Bone Chisels, Bone Mallets		129-133
13	Crown Removers, Crown Instruments		134-136
14	Implants & Measuring Instruments, Suction Tubes, Bone Gauges		137-144
15	Amalgam Guns & Carriers, Retainers, Bands, Strip Holders, Napkin Holders		145-146
16	Rubber Dam Instruments, Rubber Dam Clamps		147-148



TABLE OF CONTENTS

17	Syringes, Tweezers, Sterilizing & Lab Instruments		149-156
18	Endodontic Forceps, Tissue Forceps, Haemostatic Forceps, Towel Clamps		157-159
19	Retractors, Lip & Cheek Retractors, Hooks, Depressors & Mouth Gags, Sterilizing Forceps		160-164
20	Orthodontic Pliers & Cutters, Rongeurs		165-179
21	Needle Holders, Scissors, Micro Surgery Set		180-186
22	Impression Trays		187-193
23	Articulators, Hollow Wares		194-200
24	Scissors, Dissecting Forceps, Needle Holders, Wire Cutting Pliers With Tungsten Carbide Inserts		201-213

Section - 01



- ★ Extracting Forceps
- ★ Root Elevators



Extracting Forceps "English Pattern"



1001
Fig. 4
lower incisor



1001
Fig. 4
lower incisor



1002
Fig. 8
lower premolar



1002
Fig. 8
lower premolars



Extracting Forceps “English Pattern”



1003
 Fig. 1
 upper centrals & canines



1004
 Fig. 2
 upper laterals & canines



1005
 Fig. 3
 upper incisors & canines



1006
 Fig. 4
 upper incisors & canines



1007
 Fig. 7
 upper premolars



1008
 Fig. 8
 lower premolars



1009
 Fig. 13
 lower premolars



Extracting Forceps "English Pattern"



1010
 Fig. 13S
 lower premolars
 for children.

1011
 Fig. 17
 upper molars, right



1012
 Fig. 18
 upper molars, left



1013
 Fig. 18A
 upper molars



1014
 Fig. 18B
 upper molars



1015
 Fig. 19
 upper third molars



Extracting Forceps "English Pattern"



1016
Fig. 20
upper third molars



1017
Fig. 21
lower molars



1018
Fig. 22
lower molars



1019
Fig. 22S
lower molars
for children



1020
Fig. 22G
lower molars



1021
Fig. 23
lower molars right



1022
Fig. 24
lower molars left



Extracting Forceps "English Pattern"



1023
 Fig. 29
 upper roots



1024
 Fig. 29S
 upper roots for children



1025
 Fig. 30
 upper roots



1026
 Fig. 31
 lower roots



1027
 Fig. 32
 lower molars



1028
 Fig. 30S
 upper roots
 for children



Extracting Forceps "English Pattern"



1029
 Fig. 33
 lower roots



1030
 Fig. 33A
 lower roots



1031
 Fig. 33B
 lower roots



1032
 Fig. 33L
 lower roots



1033
 Fig. 37
 upper incisors
 for children



1034
 Fig. 33S
 lower roots
 for children



Extracting Forceps "English Pattern"



1035
 Fig. 38
 lower incisors &
 canines for children



1036
 Fig. 39
 upper molars
 for children



1037
 Fig. 39R
 upper molars right
 for children



1040
 Fig. 39L
 upper molars left
 for children



1038
 Fig. 39A
 upper molars
 for children



1039
 Fig. 40
 lower molars
 for children



Extracting Forceps "English Pattern"



1041
 Fig. 41
 upper roots



1042
 Fig. 44
 upper roots



1043
 Fig. 45
 lower roots



1044
 Fig. 48
 lower roots



1045
 Fig. 49
 upper roots



1046
 Fig. 50
 upper roots



Extracting Forceps "English Pattern"

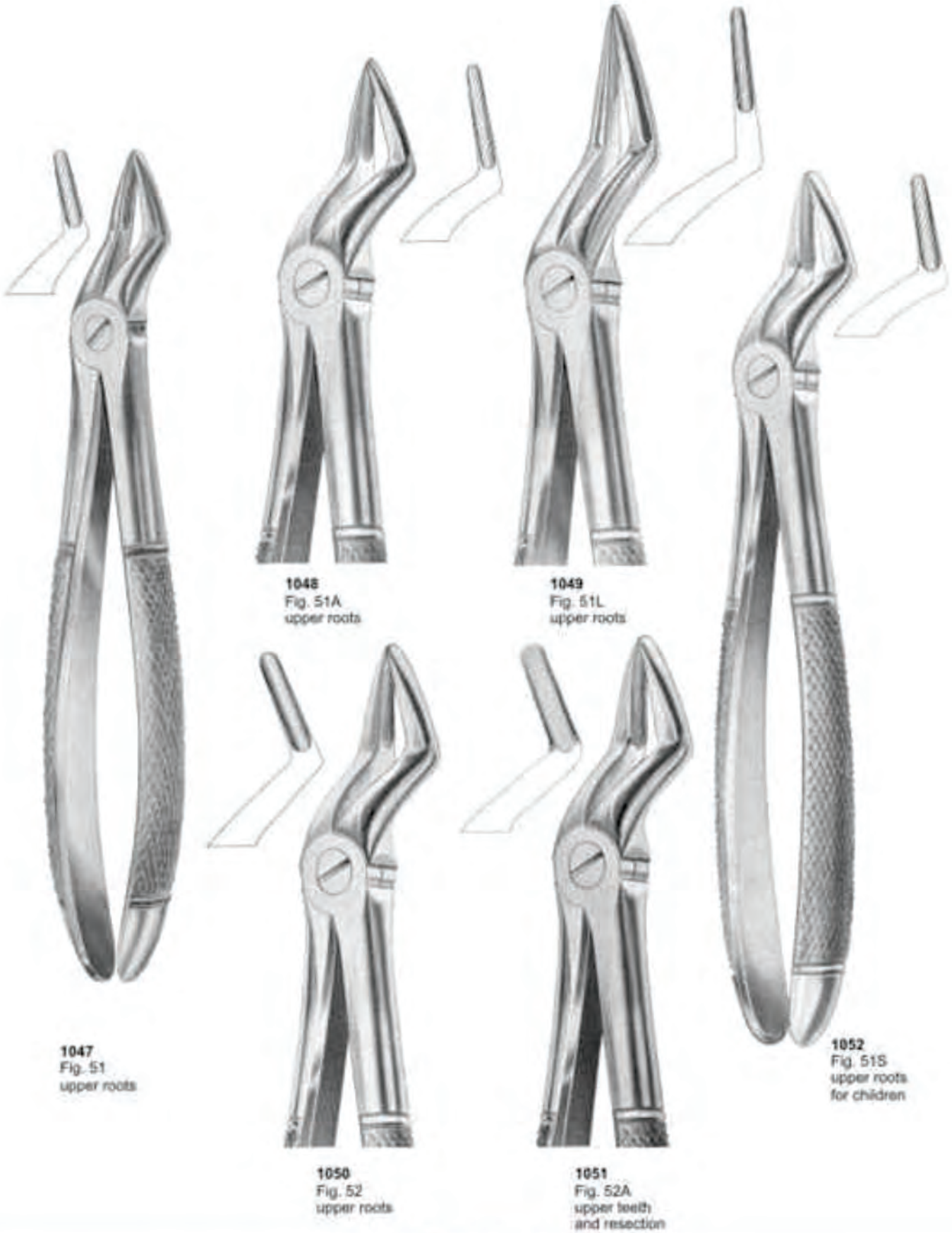



Extracting Forceps "English Pattern"



1053
Fig. 54
for separating
upper molars



1054
Fig. 55
for separating
upper molars



1055
Fig. 56
for separating
lower molars



1056
Fig. 65R
upper molars
right



1057
Fig. 65L
upper molars left



1058
Fig. 67
upper third molars



1059
Fig. 67A
upper third molars



Extracting Forceps "English Pattern"



1060
 Fig. 67 1/2 R
 upper third molars
 right



1061
 Fig. 67 1/2 L
 upper third molars
 left



1062
 Fig. 68
 lower roots



1063
 Fig. 68A
 lower roots



1064
 Fig. 73
 lower molars



1065
 Fig. 73R
 lower molars right



1066
 Fig. 73L
 lower molars left



Extracting Forceps "English Pattern"



1067
 Fig. 73A
 lower molars



1068
 Fig. 73S
 lower molars



1069
 Fig. 73B
 lower molars for children



1072
 Fig. 73K
 lower molars
 for children



1070
 Fig. 74
 lower roots



1071
 Fig. 74D
 lower roots



Extracting Forceps "English Pattern"



1073
 Fig. 74M
 lower roots



1074
 Fig. 74N
 lower roots



1075
 Fig. 74XN
 lower roots and
 crowded incisors



1078
 Fig. 76N
 upper roots



1076
 Fig. 75
 lower premolars



1077
 Fig. 76
 upper roots



Extracting Forceps "English Pattern"



1079
Fig. 76S
upper roots



1080
Fig. 79
lower third molars



1081
Fig. 79A
lower third molars



1082
Fig. 81
lower premolars
and roots



Extracting Forceps "English Pattern"



1083
 Fig. 86A
 lower molars



1084
 Fig. 86B
 lower molars



1085
 Fig. 86C
 lower molars



1086
 Fig. 87
 lower molars



1087
 Fig. 91
 for separating
 lower molars



1088
 Fig. 99
 lower molars



Extracting Forceps "English Pattern"



1089
 Fig. 101
 upper premolars
 and roots



1090
 Fig. 100
 upper roots



1091
 Fig. 99 1/4
 lower molars



1092
 Fig. 99 3/4
 lower molars



Extracting Forceps "English Pattern"



1093
Fig. 102
upper molars right



1094
Fig. 103
upper molars left



1095
Fig. 105
lower incisors



1096
Fig. 106
lower incisors



1097
Fig. 103
upper canines



Extracting Forceps "English Pattern"



1098
 Fig. 112
 upper roots



1099
 Fig. 113
 upper roots



1101
 Fig. 136
 upper premolars
 and roots



1102
 Fig. 137
 lower incisors
 and roots



1100
 Fig. 114
 upper roots



1103
 Fig. 143
 lower roots



Extracting Forceps "English Pattern"



1104
 MEAD (MD 1)
 upper anteriors,
 roots, incisors, canines



1105
 MEAD (MD 2)
 upper molars



1108
 FELSCH (Fig. 210)
 upper third molars



1106
 MEAD (MD 3)
 lower roots



1107
 MEAD (MD 4)
 lower molars



1109
 HERTZ (Fig. 211)
 lower incisors



Wisdom Extracting Forceps



1110
 ROUTURIER (Fig. 212)
 (22 1/2 L)
 lower molars
 and wisdom left



1111
 ROUTURIER (Fig. 213)
 (22 1/2 R)
 lower molars
 and wisdom right



1112
 ROUTURIER (Fig. 214)
 (22 1/2 L)
 lower molars
 and wisdom left



1113
 ROUTURIER (Fig. 215)
 (33 1/2 R)
 lower molars
 and wisdom right



1114
 RESECTION FORCEPS
 (216/Witzel)
 upper roots



Extracting Forceps "English Pattern"



1115
Fig. 5



1116
Fig. 6



1117
Fig. 9



1118
Fig. 10



1119
Fig. 11



1120
Fig. 12



1121
Fig. 14



1122
Fig. 15



Extracting Forceps "English Pattern"



1123
Fig. 25



1124
Fig. 26



1125
Fig. 27



1126
Fig. 28



1127
Fig. 34



1128
Fig. 35



1129
Fig. 42



1130
Fig. 43



Extracting Forceps "English Pattern"



1131
 Fig. 44A



1132
 Fig. 46



1133
 Fig. 47



1134
 Fig. 50A



1135
 Fig. 74R



1136
 Fig. 74L



1137
 Fig. 75R



1138
 Fig. 75L



Extracting Forceps "English Pattern"



1139
 Fig. 94



1140
 Fig. 95



1141
 Fig. 98



1142
 Fig. 105



1143
 Fig. 106



1144
 Fig. 2002



Extracting Forceps "With Fitting Handle"



1145
Fig. 1
upper laterals
and canines



1146
Fig. 2
upper laterals
and canines



1147
Fig. 3
upper incisors
and canines



1148
Fig. 4
lower incisors
and canines



1149
Fig. 7
upper premolars



1150
Fig. 13
lower premolars



1151
Fig. 13S
lower premolars
for children



Extracting Forceps "With Fitting Handle"



1152
 Fig. 17
 upper molars right



1153
 Fig. 18
 upper molars left



1154
 Fig. 18A
 upper molars



1155
 Fig. 18B
 upper molars



1156
 Fig. 19
 upper third molars



1157
 Fig. 22
 lower molars



1158
 Fig. 22S
 lower molars
 for children



Extracting Forceps "With Fitting Handle"



1159
 Fig. 29
 upper roots



1160
 Fig. 29S
 upper roots
 for children



1161
 Fig. 30
 upper roots



1162
 Fig. 30S
 upper roots
 for children



1163
 Fig. 33
 lower roots



1164
 Fig. 33A
 lower roots



1165
 Fig. 33B
 lower roots



Extracting Forceps "With Fitting Handle"



1166
 Fig. 33L
 lower roots



1167
 Fig. 33S
 lower roots
 for children



1168
 Fig. 37
 upper incisors
 for children



1169
 Fig. 39
 upper incisors
 for children



1170
 Fig. 38A
 upper molars
 for children



1171
 Fig. 38R
 upper molars right
 for children



1172
 Fig. 38L
 upper molars left
 for children



Extracting Forceps "With Fitting Handle"



1173
Fig. 41
upper roots



1174
Fig. 44
upper roots



1175
Fig. 45
lower roots



1176
Fig. 48
lower roots



1177
Fig. 51
upper roots



1178
Fig. 51A
upper roots



1179
Fig. 51S
upper roots
for children



Extracting Forceps "With Fitting Handle"



1180
 Fig. 51L
 upper roots



1181
 Fig. 52
 upper roots



1182
 Fig. 54
 for separating
 upper molars



1183
 Fig. 65R
 upper molars right



1184
 Fig. 65L
 upper molars left



1185
 Fig. 67
 upper third molars



1186
 Fig. 67A
 upper third molars



Extracting Forceps "With Fitting Handle"



1187
Fig. 67 1/2 R
upper third molars
right



1188
Fig. 67 1/2 L
upper third molars
left



1189
Fig. 73
lower molars



1190
Fig. 74
lower roots



1191
Fig. 74M
lower roots



1192
Fig. 74N
lower roots



1193
Fig. 74XN
lower roots and
crowded incisors



Extracting Forceps “With Fitting Handle”



1194
 Fig. 75
 lower premolars



1195
 Fig. 76
 upper roots



1196
 Fig. 76N
 upper roots



1199
 Fig. 79
 lower third molars



1197
 Fig. 81
 lower premolars
 and roots



1198
 Fig. 76A
 lower third molars



Extracting Forceps “With Fitting Handle”



1200
 Fig. 86A
 lower molars.



1201
 Fig. 86B
 lower molars



1202
 Fig. 86C
 lower molars



1203
 Fig. 99
 lower molars



1204
 Fig. 99 1/4
 lower molars



1205
 Fig. 136
 upper premolars
 and roots



1206
 Fig. 143
 lower roots



Extracting Forceps "For Children"



1207
KLEIN (Fig. 217)
upper incisors



1208
KLEIN (Fig. 218)
upper premolars



1209
KLEIN (Fig. 219)
upper roots



1210
KLEIN (Fig. 220)
upper molars



1211
KLEIN (Fig. 221)
lower incisors



1212
KLEIN (Fig. 222)
lower molars



1213
KLEIN (Fig. 223)
lower roots



1214
ALBRECHT
Fig. 224
Deciduous



1215
ALBRECHT
Fig. 225
Deciduous



Root Splinter Forceps



1216
 WITZEL
 Fig. 226
 lower roots

1217
 WITZEL
 Fig. 227
 upper roots



1218
 ARTHUR
 Fig. 228
 root fragments

1219
 STIEGLITZ
 Fig. 229
 root fragments



1220
 STIEGLITZ
 Fig. 230
 root fragments



1221
 RALK
 Fig. 231
 root fragments



Extracting Forceps "American Pattern"



1222
 W1-WINTER
 upper centrals
 and canines



1223
 Fig. 1
 upper incisors and roots



1224
 Fig. 2
 upper and lower roots



1225
 Fig. 4
 upper and lower premolars



1226
 PHYSICK
 Fig. 5
 lower third molars



1227
 Fig. 6
 separating
 forceps



Extracting Forceps "American Pattern"



1228
 Fig. 7
 upper roots



1229
 Fig. 8
 upper and lower
 third molars



1231
 Fig. 10H
 upper molars



1232
 Fig. 13
 upper incisors



1230
 Fig. 10S
 upper molars



1233
 Fig. 14
 lower incisors



Extracting Forceps "American Pattern"



1234
 Fig. 16
 lower molars



1235
 HARRIS
 Fig. 15
 lower molars



1237
 HARRIS
 Fig. 18R
 upper molars right



1238
 HARRIS
 Fig. 18L
 upper molars left



1236
 Fig. 16S
 lower molars
 for children



1239
 Fig. 17
 lower molars



Extracting Forceps "American Pattern"

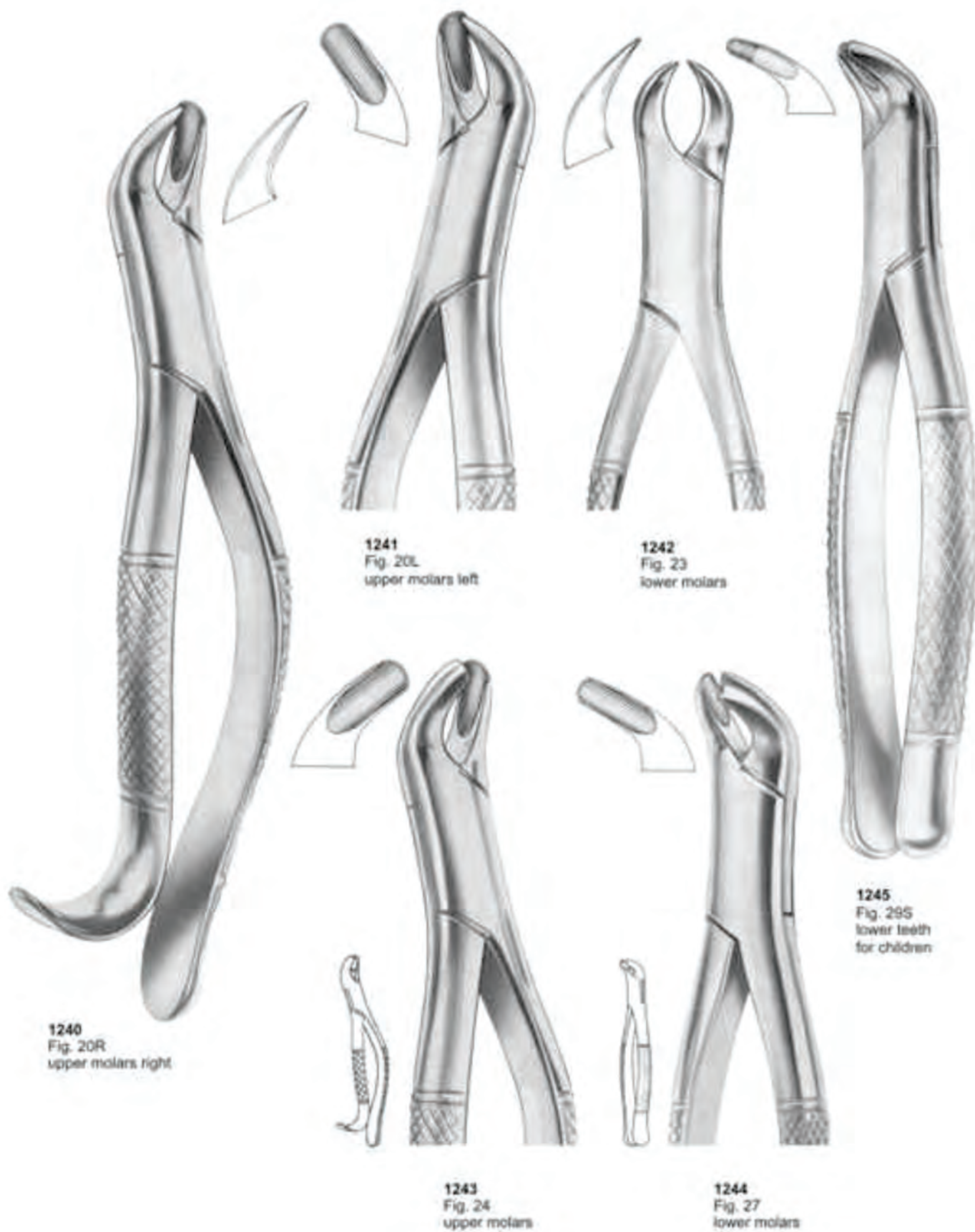



Extracting Forceps "American Pattern"



1246
 Fig. 30S
 upper teeth
 for children



1247
 PARMLY
 Fig. 32
 upper premolars
 and molars



1248
 PARMLY
 Fig. 32A
 upper premolars
 and roots



1249
 Fig. 34
 lower anteriors
 and roots



1250
 Fig. 35
 upper roots



1251
 Fig. 38
 lower anteriors
 and roots



Extracting Forceps "American Pattern"



1252
Fig. 37
lower anteriors
and roots



1254
Fig. S3R
upper molars right



1255
Fig. S3L
upper molars left



1253
Fig. 38
upper anteriors
and roots



1256
Fig. 62
incisors, premolars,
deciduous teeth



1257
Fig. 65
upper incisors
and roots



Extracting Forceps "American Pattern"



1258
 TOMEs
 Fig. 69
 upper and lower roots



1259
 TOMEs
 Fig. 85
 lower canines,
 premolars and molars



1260
 NEVIUS
 Fig. 88R
 upper molars right



1261
 THOMAS
 Fig. 85A
 lower canines,
 premolars and molars



1262
 NEVIUS
 Fig. 88L
 upper molars left



Extracting Forceps "American Pattern"



1263
 KELLS
 Fig. 99A
 upper incisors,
 canines, premolars



1264
 Fig. 104
 upper third molars



1266
 HULL
 Fig. 101
 deciduous teeth



1267
 Fig. 103
 lower incisors,
 premolars



1265
 KELLS
 Fig. 99C
 upper incisors,
 canines, premolars



Extracting Forceps "American Pattern"



1268
 CRYER
 Fig. 150
 lower incisors,
 premolars, roots



1269
 CRYER
 Fig. 150A
 upper incisors,
 premolars, roots



1271
 CRYER
 Fig. 151
 lower incisors,
 premolars, roots



1272
 CRYER
 Fig. 151A
 lower incisors,
 premolars, roots



1270
 CRYER
 Fig. 150S
 upper teeth for children



1273
 CRYER
 Fig. 151S
 lower teeth
 for children



Extracting Forceps "American Pattern"



1274
 Fig. 203
 lower incisors
 and roots



1275
 Fig. 210S
 upper third molars



1277
 Fig. 210H
 upper third molars



1278
 Fig. 213
 upper centrals and canines



1276
 Fig. 201
 upper incisors,
 canines, premolars



1279
 Fig. 217
 lower molars



Extracting Forceps "American Pattern"



1280
 Fig. 222
 lower third molars



1282
 Fig. 286
 Swing lower molars



1283
 Fig. 288
 lower canines
 and premolars



1281
 Fig. 285
 upper incisors and roots



Extracting Forceps "American Pattern"



1284
 COHEN
 Fig. 310
 universal forceps



1285
 NEVIUS
 Fig. 320/10S
 upper canines.



1287
 NEVIUS
 Fig. 325/10H
 upper canines



1288
 STANDARD
 Fig. 330/4
 upper third molars



1286
 HENAHAN
 Fig. 315/1A upper incisors



Extracting Forceps "American Pattern"



1289
 WOODWARD
 Fig. 335/FH
 lower molars



1290
 Fig. 340/89
 upper molars right



1292
 Fig. 345/90
 upper molars left



1291
 WOODWARD
 Fig. 335/FS
 lower molars



Forceps For Children "American Pattern"



1293
 Fig. 350/235
 lower molars



1294
 Fig. 355/235K
 lower molars



1295
 Forcep Fig. 301



1295-A
 Forcep Fig. 300



1296
 Fig. 360/175K
 lower molars



1297
 Fig. 365/1505K
 upper anteriors
 and roots



1298
 Fig. 370/1515K
 lower anteriors
 and roots



Peristeel Elevators



1299
Molt 9



1300
Allen 9A



1301
Prichard



1302
Seldin



1303
Goldman- Fox 14



1304
West-
Dell W2



Elevators

Heidbrink Root - Tip Picks

Root Tip



1305
DEL 78



1306
DEL 79



1307
DEL 80



1308
DEL H1



1309
DEL H2



1310
DEL H3



1311
DEL H2-3



1312
POTT
6X



1313
POTT
7X



Periosteal Elevators



1314
BUSER



1315
OHI 10



1316
HOWARD 9H



1317
FREER



1318
FREER 15



1319
FREER 16



Root Elevators

lower jaw, left side

lower jaw, right side



1320
BEIN
Fig. 4



1331



1332



1321
BEIN
1.0 mm

1322
BEIN
1.5 mm

1323
BEIN
2.0 mm

1324
BEIN
2.5 mm

1325
BEIN
3.0 mm

1326
BEIN
3.5 mm

1327
BEIN
4.0 mm

1328
BEIN
4.5 mm

1329
BEIN
5.0 mm

1330
BEIN
5.5 mm



Root Elevators



1333
 BEIN



1334
 BEIN
 Fig. 1



1335
 BEIN
 Fig. 2



1336
 BEIN
 Fig. 0



1337
 BEIN
 Fig. 3



1338
 BEIN
 Fig. 4



1339
 BEIN
 Fig. 5



1340
 BEIN
 Fig. 6



Root Elevators



1341
 CRYER
 Fig. 3



1342
 CRYER
 Fig. 4



1343
 CRYER
 Fig. 12



1344
 CRYER
 Fig. 27



1345
 CRYER
 Fig. 28



1346
 CRYER
 Fig. 27S



1347
 CRYER
 Fig. 28S



1348
 SELDIN
 Fig. 2



1349
 SELDIN
 Fig. 3



1350
 SELDIN
 Fig. 4L



1351
 SELDIN
 Fig. 4R



1352
 SELDIN
 Fig. 1L



1353
 SELDIN
 Fig. 1R



Swa Elevators & Root Screws



1354



1355



1356



1357



1358



1359



1360

Root Screws



1362
 Morrison
 2.0 mm



1363
 Morrison
 2.5 mm



1364
 Morrison
 3.0 mm



1361
 Morrison
 3.5 mm



Root Elevators



1365
IS-APICAL



1366
APICAL
2 mm
Fig. 1



1367
APICAL
3 mm
Fig. 2



1368
APICAL
4 mm
Fig. 3



1369
APICAL
4.5 mm
Fig. 4



1370
APICAL
2 mm
Fig. 5



1371
APICAL
3 mm
Fig. 6



1372
APICAL
4 mm
Fig. 7



1373
APICAL
4.5 mm
Fig. 8



1374
APICAL
Fig. 9



1375
WINTER
Fig. 14 L



1376
WINTER
Fig. 14 R



1377
HEIDBRINK
Fig. 1



1378
HEIDBRINK
Fig. 2



1379
FLOHR
Fig. 1



1380
FLOHR
Fig. 2



1381
APICAL
Fig. 1



1382
APICAL
Fig. 2



Root Elevators



1383
 IS-CRYER



1384
 CRYER
 Fig. 1



1385
 CRYER
 Fig. 2



1386
 IS-COUPLAND



1387
 COUPLAND
 Fig. 1



1388
 COUPLAND
 Fig. 2



1389
 COUPLAND
 Fig. 3



Root Elevators



1390
Fig. 1



1391
Fig. 2



1392
Fig. 3



1393
FLOHR
Fig. 1



1394
FLOHR
Fig. 2



1395
FLOHR
Fig. 3



Root Elevators



1396
 KOPP
 Fig. 1



1397
 KOPP
 Fig. 2



1403
 KOPP
 Fig. 1



1404
 KOPP
 Fig. 2



1396
 KOPP



1398
 KOPP
 Fig. 3



1399
 KOPP
 Fig. 4



1402
 KOPP



1405
 KOPP
 Fig. 3



1406
 KOPP
 Fig. 4



1400
 KOPP
 Fig. 5



1401
 KOPP
 Fig. 6



Root Elevators



1407
 HYLIN
 Fig. 1



1409
 BEIN
 Fig. 1



1410
 BEIN
 Fig. 2



1407
 HYLIN



1408
 HYLIN
 Fig. 2



1409
 BEIN



1411
 BEIN
 Fig. 3



1412
 BEIN
 Fig. 4



Root Elevators



1413
 WARWICK-JAMES
 Fig. 1



1413
 Warwick-James
 Fig. 2



1414
 Warwick-James
 Fig. 3



1415
 London-Hospital
 Fig. 1



1415
 London-Hospital
 Fig. 2



1416
 London-Hospital
 Fig. 3



1417
 OTT



Root Elevators



1418
 CHOMPRET
 Fig. 1



1419
 CHOMPRET
 Fig. 2



1420
 CHOMPRET
 Fig. 3



1421
 CHOMPRET
 Fig. 4



1423
 Fig. 1



1422
 Fig. 2



1424
 Fig. 1



1425
 Fig. 2



1426
 APICAL



Root Tip Elevators



1427
 IS-Fig. 1



1428
 Fig. 2



1429
 Fig. 3



1430
 HEIDBRINK
 Fig. 1



1431
 HEIDBRINK
 Fig. 2



1432
 HEIDBRINK
 Fig. 3



1438
 MEAD
 MD1



1433
 LECLUSE



1434
 MEAD
 MD-5 A



1435
 MEAD
 MD-6 A



1436
 MEAD
 MD-7 A



1437
 MEAD
 MD-8



Root Elevators



1439
 WINTER
 Fig. 1L



1440
 WINTER
 Fig. 1R



1441
 WINTER
 Fig. 2L



1442
 WINTER
 Fig. 2R



1439
 WINTER



1443
 WINTER
 Fig. 11L



1444
 WINTER
 Fig. 11R



1445
 WINTER
 Fig. 12L



1446
 WINTER
 Fig. 12R



1447
 WINTER
 Fig. 14L



1448
 WINTER
 Fig. 14R



Root Elevators



1449
BARRY
Fig. 1



1450
BARRY
Fig. 2



1451
BARRY
Fig. 3



1452
BARRY
Fig. 4



1449
BARRY



1453
BARRY
Fig. 11



1454
BARRY
Fig. 12



1455
BARRY
Fig. 17



1456
BARRY
Fig. 18



Root Elevators



1458
CRYER
Fig. 26



1459
SELDIN
Fig. 27



1460
CRYER
Fig. 28



1461
CRYER
Fig. 29



1462
HEIDBRINK
Fig. 22



1463
HEIDBRINK
Fig. 23



1457



Root Elevators



1465
KOPP
Fig. 31



1466
KOPP
Fig. 32



1467
KOPP
Fig. 33



1468
KOPP
Fig. 34



1469
KOPP
Fig. 35



1470
KOPP
Fig. 44



1464



Root Elevators



1472
 HEIDBRINK
 Fig. 10



1473
 WINTER
 Fig. 11



1474
 WINTER
 Fig. 12



1475
 BARRY
 Fig. 17



1476
 BARRY
 Fig. 18



1477
 BARRY
 Fig. 20



1471

Root Elevators according to Dr. Sader,
 with interchangeable working tips



1478



1479



1480



Elevators Plastic Handle

1481
Root Elevator, Plastic Handle, Set of 10 Pcs

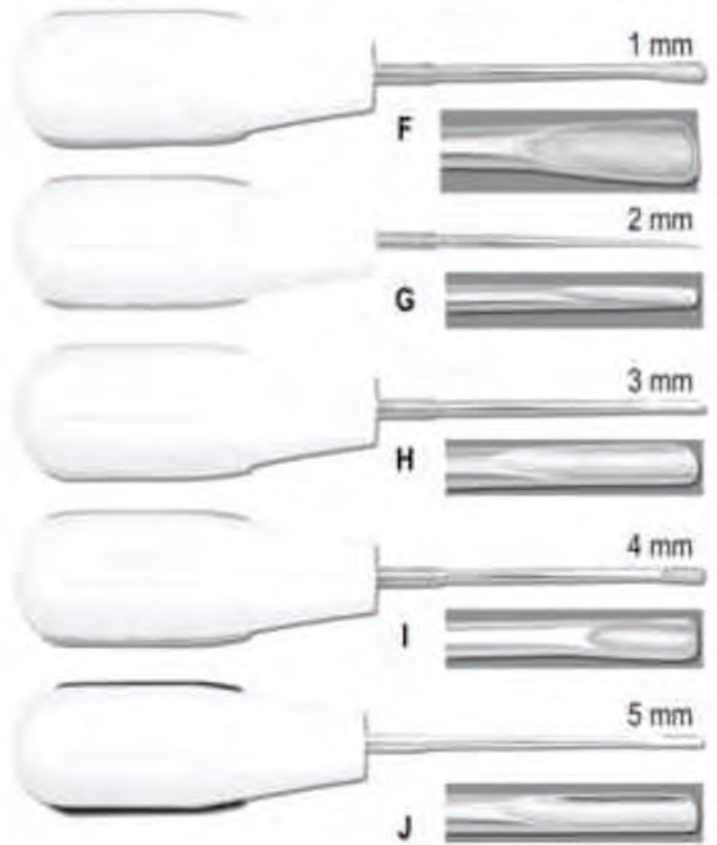
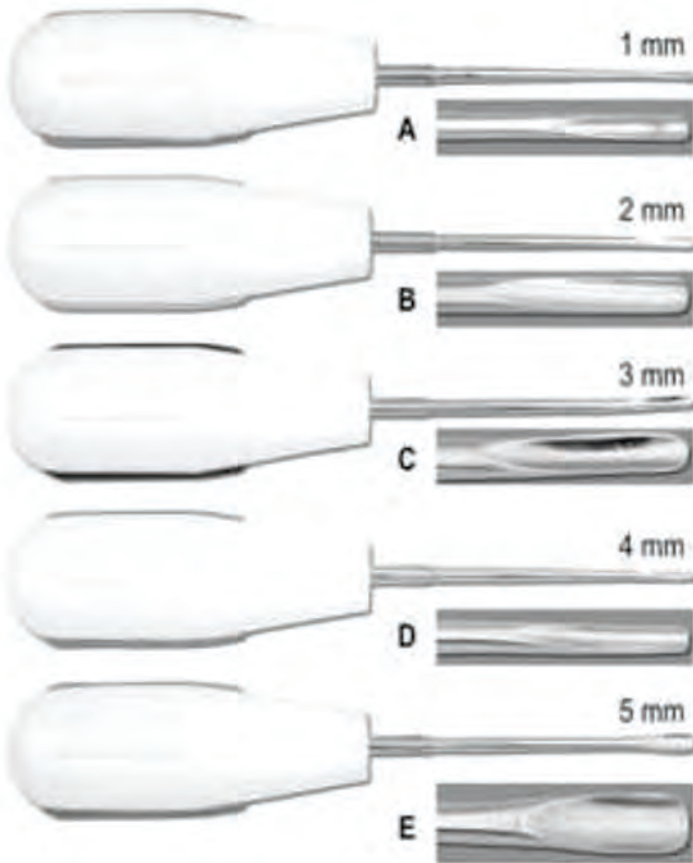

1482
Root Elevator, Plastic Handle, Set of 5 Pcs

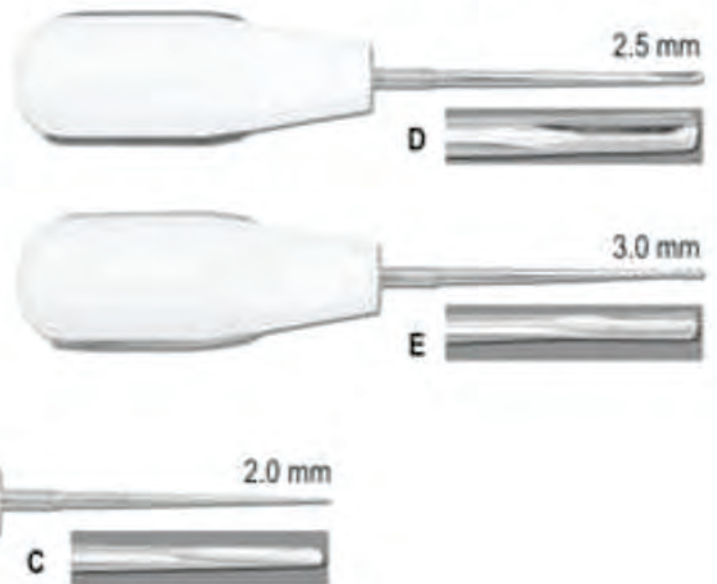
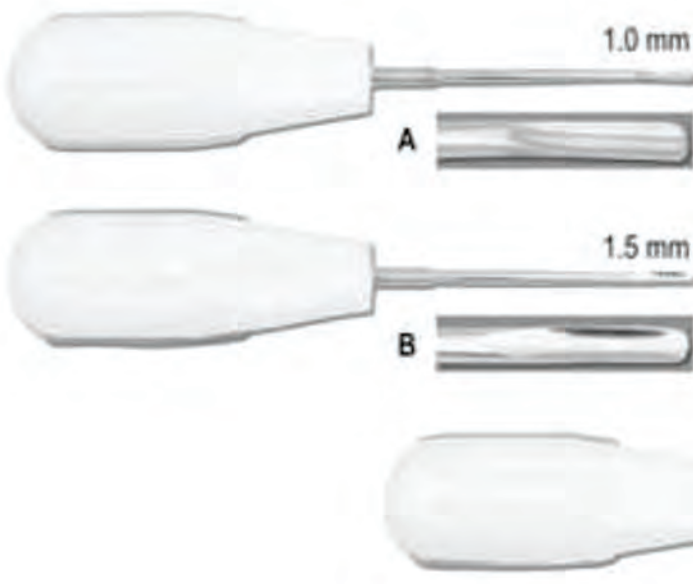

Section - 02



- ★ Scalpel Handles
- ★ Mouth Mirrors, Handles
- ★ Scalers
- ★ Explorers
- ★ Probes
- ★ Condensers
- ★ Excavators





Scalpel Handles



1483
Scalpel Handle Angle Of Blade Adjusts To Easily Get Around Corners
Adjustment Sets Blade From Straight To Back Angled
Locks In At 90°, 60°, 30°, Straight, -30°, -60° Angles



1484
Scalpel Handle
Fig. 5



1485
Scalpel Handle
Curved



1486
Fig. 3L



1487
Fig. 7



1488
Scalpel Handle
Fig. 4L, Curved
20 cm



1489
Fig. 3



1490
Fig. 3G



1491
Fig. 4



1492



1493
Scalpel Handle
4 D 14.0 cm



1494
Mess Holders



1495
Gouge
Blade Handle
Fig. 2 / 11.5 cm



Handles

Handle For Mouth Mirrors, Probes, Explorers, Excavators, Carvers, Curettes & Scalers



1496
 Handle No. 2 Standard Single Ended



1497
 Handle Single Ended



1498
 Handle Single Ended



1499
 Handle Single Ended



1500
 Octagonal Double Ended



1501
 Octagonal Double Ended



1502
 Octagonal Double Ended



1503
 Handle No. 2 (Standard Double Ended)



1504
 Octagonal Double Ended



1505
 Tactile Tone Double Ended



1506
 Tactile Tone Double Ended



1507
 Tactile Tone Double Ended



1508
 Handle, Double Ended



1509
 Double Ended



1510
 Tactile Tone Double Ended



1511
 Tactile Tone Double Ended



Handles & Mouth Mirrors

Mouth Mirrors, Magnifying 1513-A Plain 1512-B

Fig. 00	Ø	8 mm
Fig. 0	Ø	10 mm
Fig. 1	Ø	14 mm
Fig. 2	Ø	16 mm
Fig. 3	Ø	18 mm
Fig. 4	Ø	20 mm
Fig. 5	Ø	22 mm
Fig. 6	Ø	24 mm
Fig. 7	Ø	26 mm
Fig. 8	Ø	28 mm
Fig. 9	Ø	30 mm
Fig. 10	Ø	32 mm

1513-A

Mouth Mirrors

Plane



Magnifying



Front surface

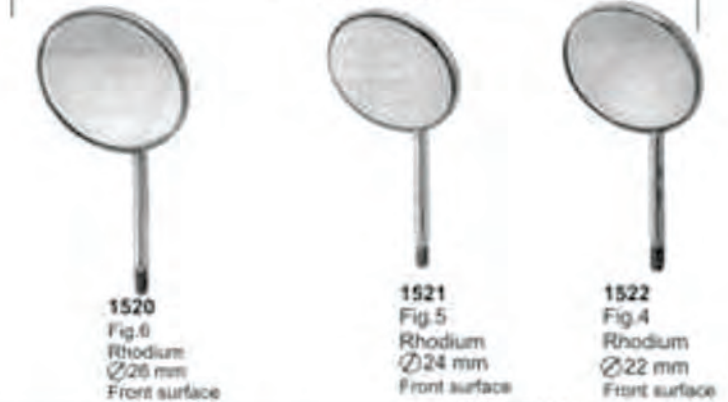

Plane



Magnifying



With cone - socket

1512
Hollow Handle
Fig.1

1513
Hollow Handle
Fig.2

1523
Fig.6
Ø 26 mm

1524
Fig.5
Ø 24 mm

1525
Fig.4
Ø 22 mm

1526
Fig.6
Ø 26 mm

1527
Fig.5
Ø 24 mm

1528
Fig.4
Ø 22 mm



Mirror Handle, Mouth Mirrors



1529



1530



1531



1532



1533



1534



1535
 Parallelometer
 mouth mirror

1536
 Parallelometer
 mouth mirror
 + handle
 code 2101



1537
 Tactile Tone
 Single Ended



1538
 Handle
 Thompson
 Single Ended



1539
 Hollow Handle



1540
 Hollow Handle
 Stainless
 Steel



1541
 Cone-socket
 Hollow Handle



1542
 Hollow Handle



1543
 Hollow Handle



Scalers

SCALERS - JAQUETTE



1544 1Y-1Y
1545 1Y-1YS
1546 2Y-3Y
1547 2YS-3YS
1548 2-3
1549 2S-3S
1550 Fig.1

SCALERS - OCTAGONAL



1551 U15-30
1552 U15-33
1553 H5-33
1554 H6-7
1555 Taylor 2-3
1556 CK6



Scalers



1557
U15



1558
No. 3



1559
No. 12



1560
WHITESIDE 1-0



1561
WHITESIDE 2-0



Scalers



1562
YAOUNGER/GOOD
7-8



1563
H5-33



1564
204SD



1565
H6-7



1566
204S



1567
TOWNER/JAQUETTE
U15-30



Scalers



1568
 JAQUETTE (33-U15)



1569
 JAQUETTE
 2Y-3Y



1570
 JAQUETTE
 30-U15



1571
 JAQUETTE
 2YS-3YS



1572
 JAQUETTE
 33-H5



1573
 YOUNGER/GOOD
 7-8



1574
 204S



1575
 20450



1576
 H6-7



1577
 JAQUETTE
 25-35



1578
 JAQUETTE
 1Y-1YS



1579
 JAQUETTE
 2-3



Scalers



1580
JAQUETTE (33-U15)



1581
S204



1583
S204S

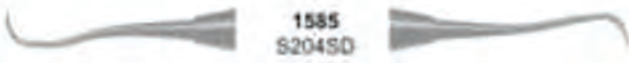

1585
S204SD



1587
Goldman 6-7



1589
Goldman Fox 21



1591
HS-U15

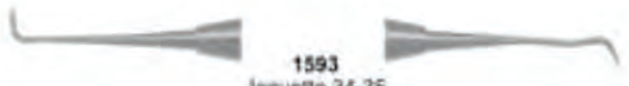

1593
Jaquette 34-35

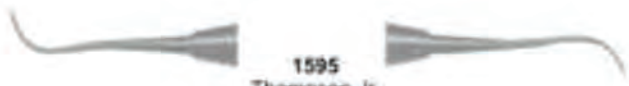

1595
Thompson Jr.



1597
UT107-108



1599
UP128



1582
Jack-Nebraska



1584
Jaquette 1-U15



1586
Jaquette 2-3

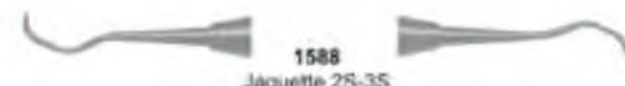

1588
Jaquette 2S-3S

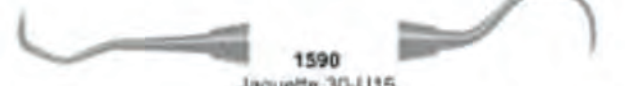

1590
Jaquette 30-U15

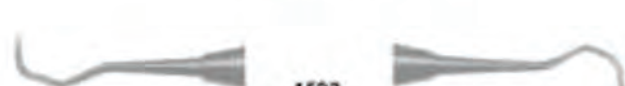

1592
Jaquette 30-33



1594
Jaquette 31-32



1596
Jaquette 33-H5



1598
U 6-7



1600
128L



Explorers

Explorers Double Ended - Octagonal

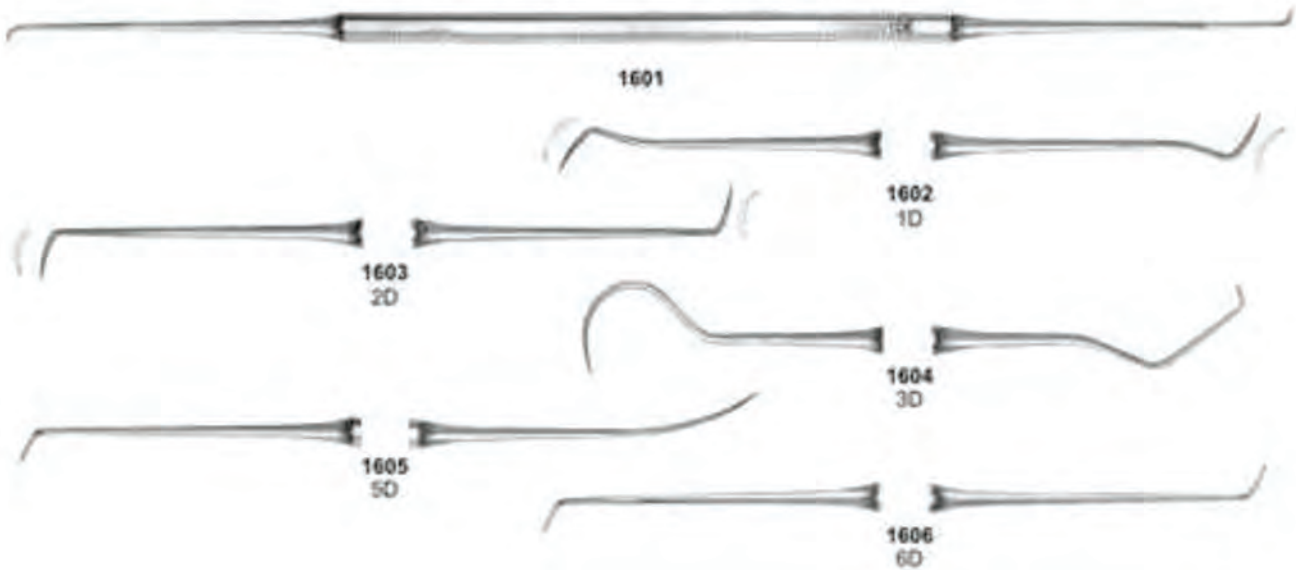

Explorers Double Ended - Standard

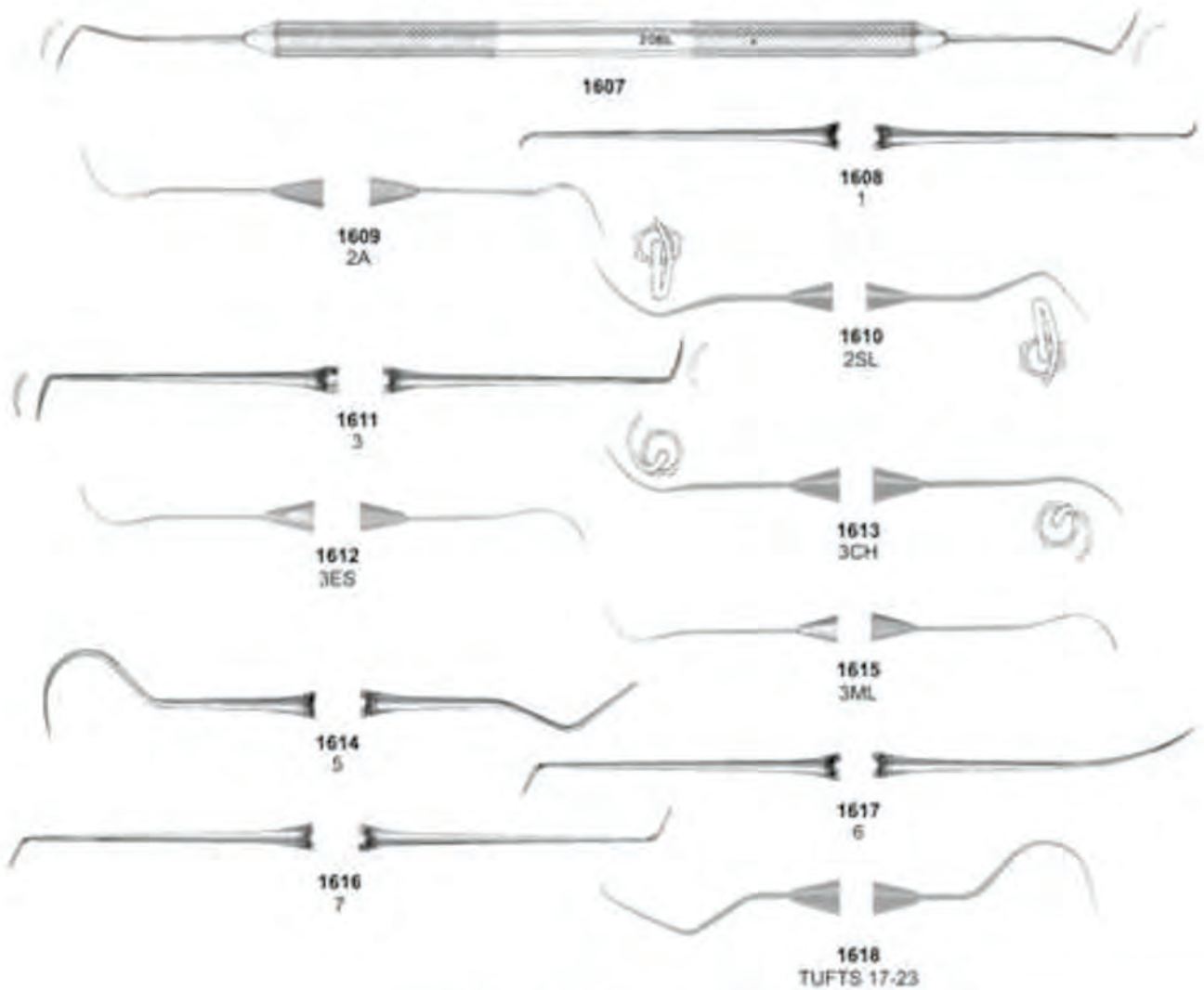



Explorers

Explorers Double Ended Tactile Tone





Explorers & Probes

Explorers Single Ended - Octagonal



1632
Fig. 3A



1633
Fig. 6



1634
Fig. 7



1635
Fig. 17



1636
Fig. 23

Explorers Single Ended - Standard



1637
Fig. 3A



1638
Fig. 6



1639
Fig. 7



1640
Fig. 17



1641
Fig. 23

Probe / Explorer - Octagonal



1642
GF-17

Double Ended Probe - Octagonal

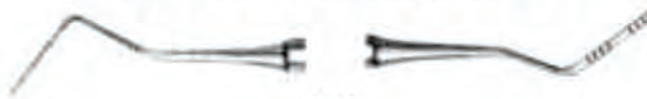

1643
GF-18 (1-2)



Probes

Probes Double Ended - Standard

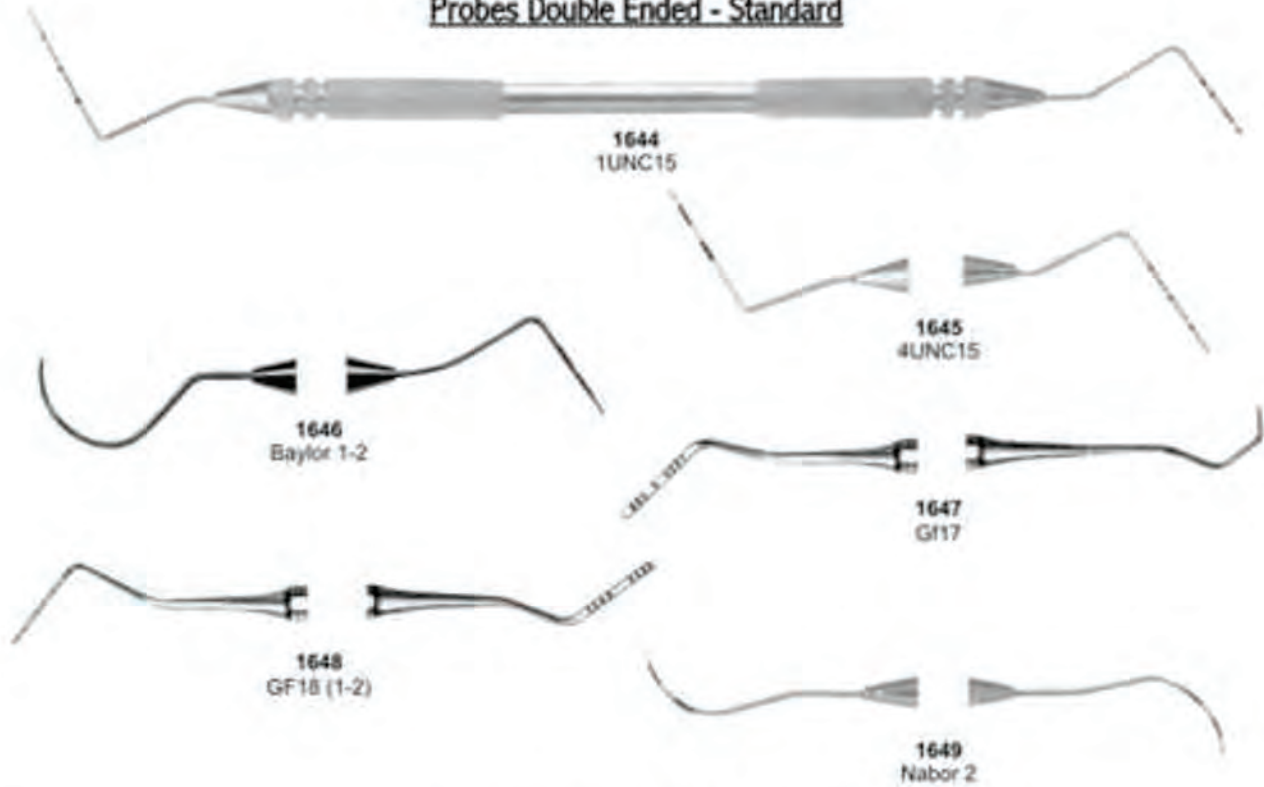

Probes Double Ended - Tactile Tone

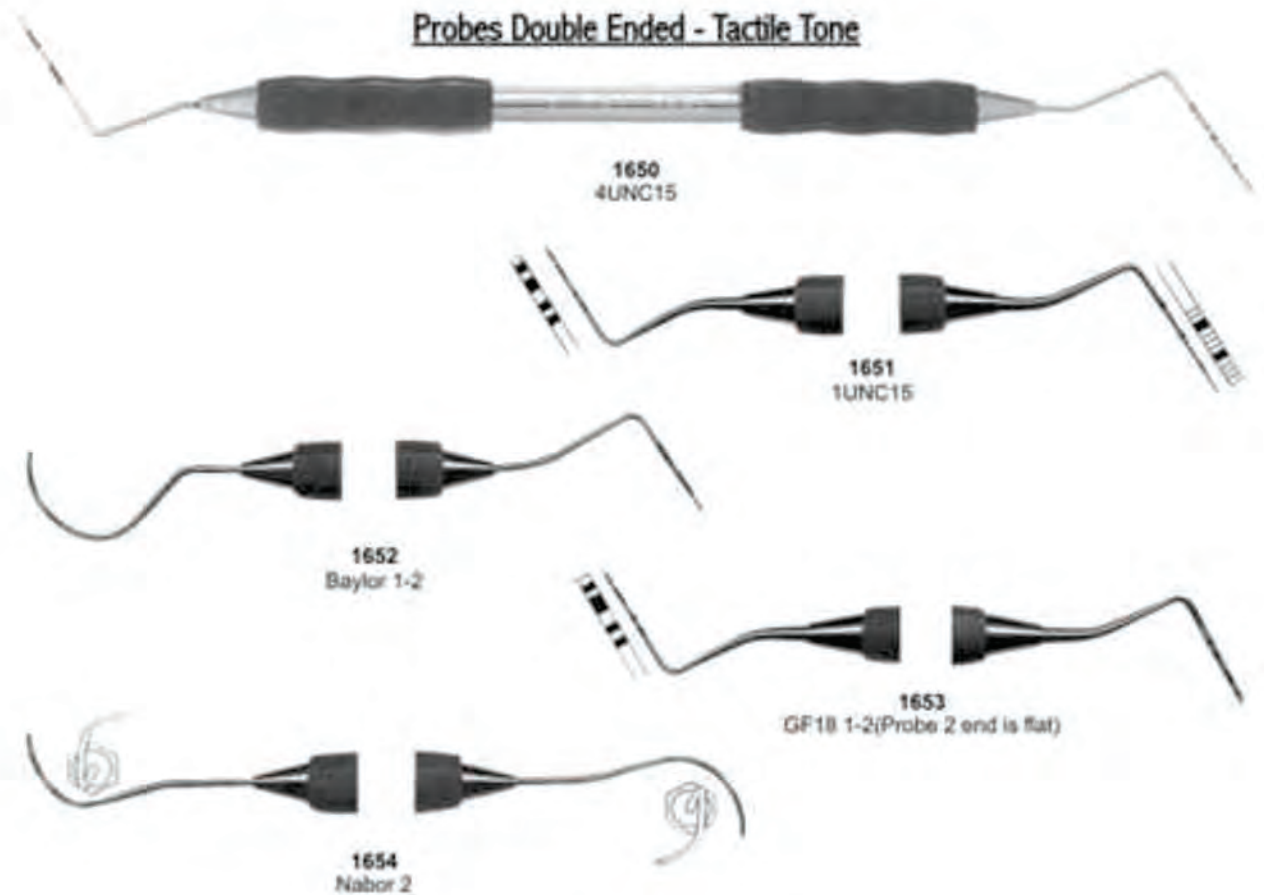



Probes

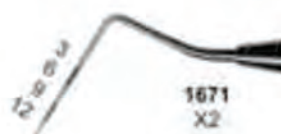
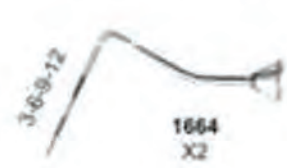



Probes

PROBES DOUBLE ENDED STANDARD

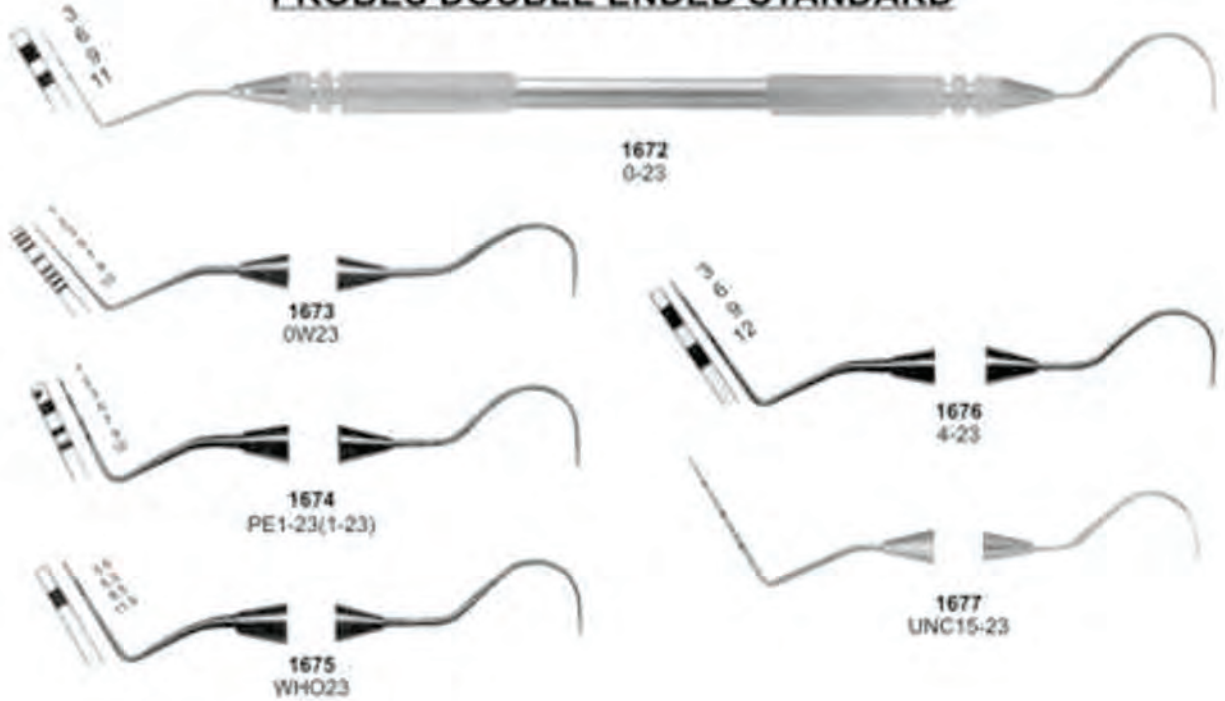

PROBES DOUBLE ENDED TACTILE TONE

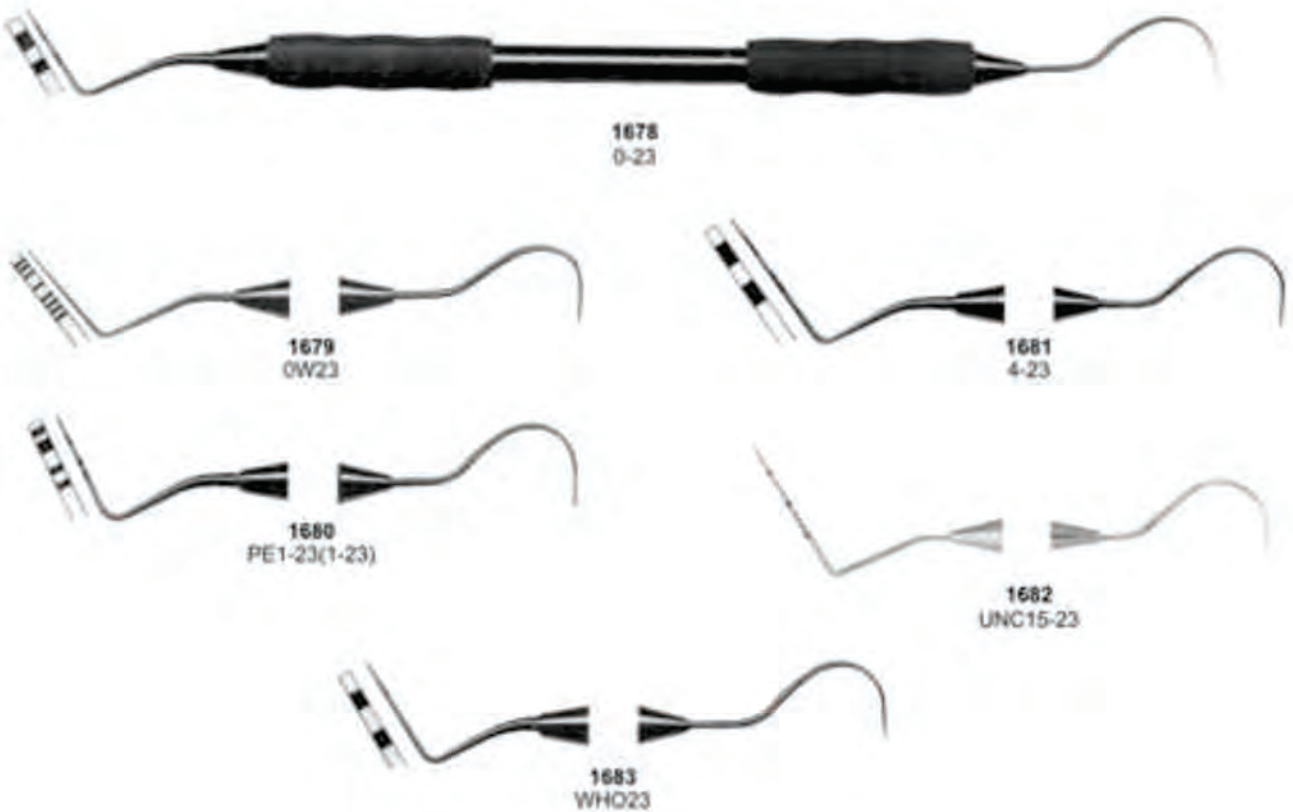



Endodontic Condensers

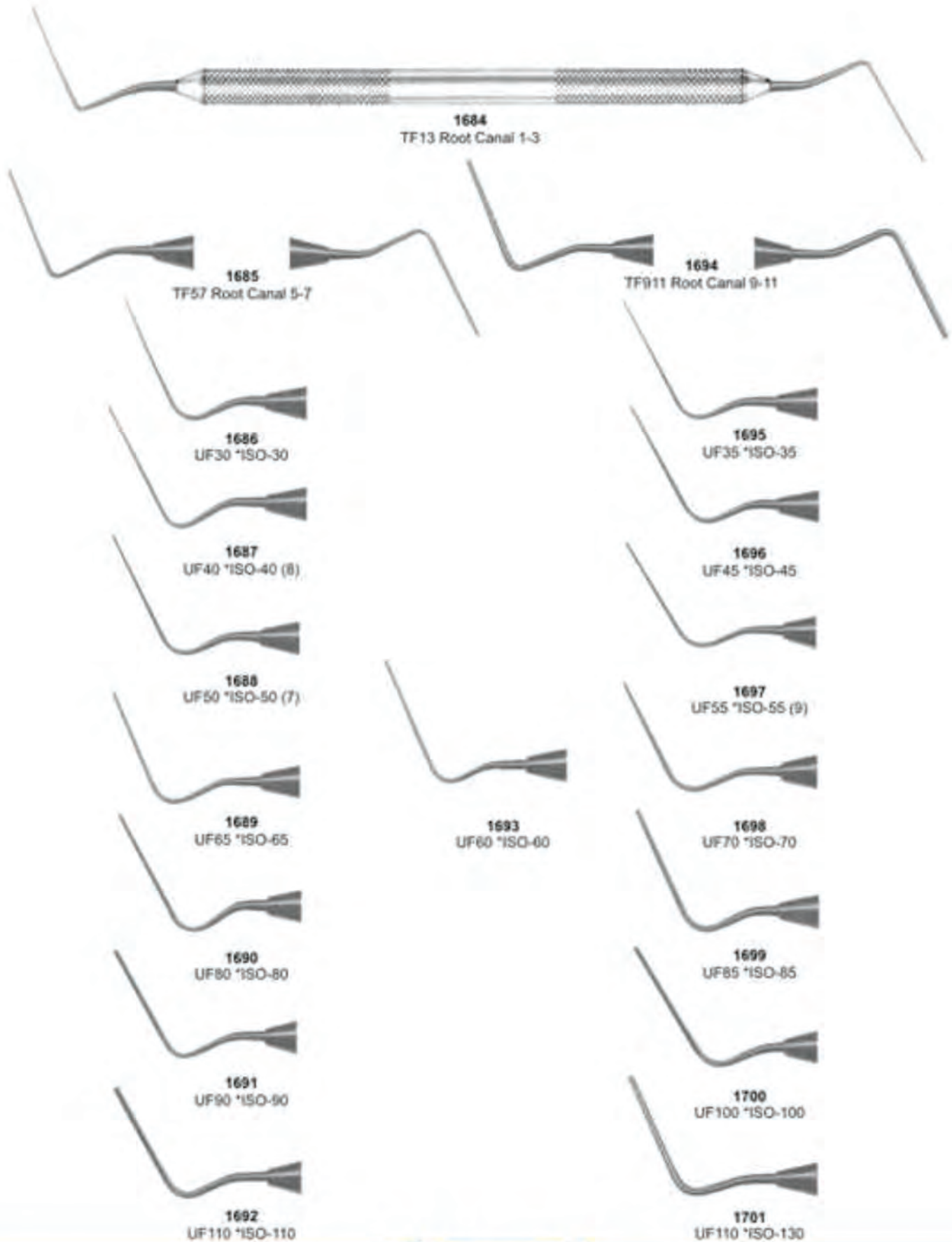



Endodontic Condensers/Spreaders



1702
 UF120X



1703
 UF45N



1704
 UF60N



1705
 UF80N



1706
 UF100X



1707
 UE25 R-25



1708
 UE30 R-30



1709
 UE35 R-35



1710
 UE40 R-40



1711
 UE45 R-45



1712
 UE50 R-50



1713
 UF120X



1714
 UF140X



1715
 TFD3545N



1716
 TFD6080N



1717
 UE55 R-55



1718
 UE60 R-60



1719
 UE25N R-25



1720
 UE30N R-30



1721
 UE40N R-40



Obturation Instruments

1722
No. D11



D1 .33mm, D16 .95mm

1723
No. D11T



D1 .24mm, D2 .84mm

1724
No. KR1



D1 .23mm, D2 .81mm

1725
No. 25S



D1 .28mm, D2 .83mm

1726
No. W1S



D1 .25mm, D16 .85mm

1727
No. W2S



D1 .40mm, D2 .70mm



1728
Lucks No.1



1729
Lucks No.2



1730
Lucks No.3



1731
Lucks No.4

1732
No. 5, D(1mm).50mm, .55mm D(5mm)
D(16mm), .85mm, .75mm D(16mm)

1733
No. 7, D(1mm).70mm, .50mm D(5mm)
D(16mm), 1.00mm, .75mm D(16mm)

1734
No. 9, D(1mm)1.00mm, .63mm D(5mm)
D(16mm), 1.30mm, .75mm D(16mm)

1735
No. 11, D(1mm)1.20mm, .63mm D(5mm)
D(16mm), 1.50mm, .75mm D(16mm)

1736
No.1 (D1 .35mm, D16 .75mm)

1737
No.2 D1 .35mm, D16 .85mm

1738
No.3 D1 .85mm, D16 1.15mm

1739
No.4 D1 1.00mm, D16 1.30mm

1740
No.1-3 - D1 .25mm/D1 .35mm

1741
No.3-5 - D1 .35mm/D1 .55mm

1742
No.5-7 - D1 .55mm/D1 .70mm

1743
No.9-11 - D1 1.00mm/D1 1.20mm



Excavators

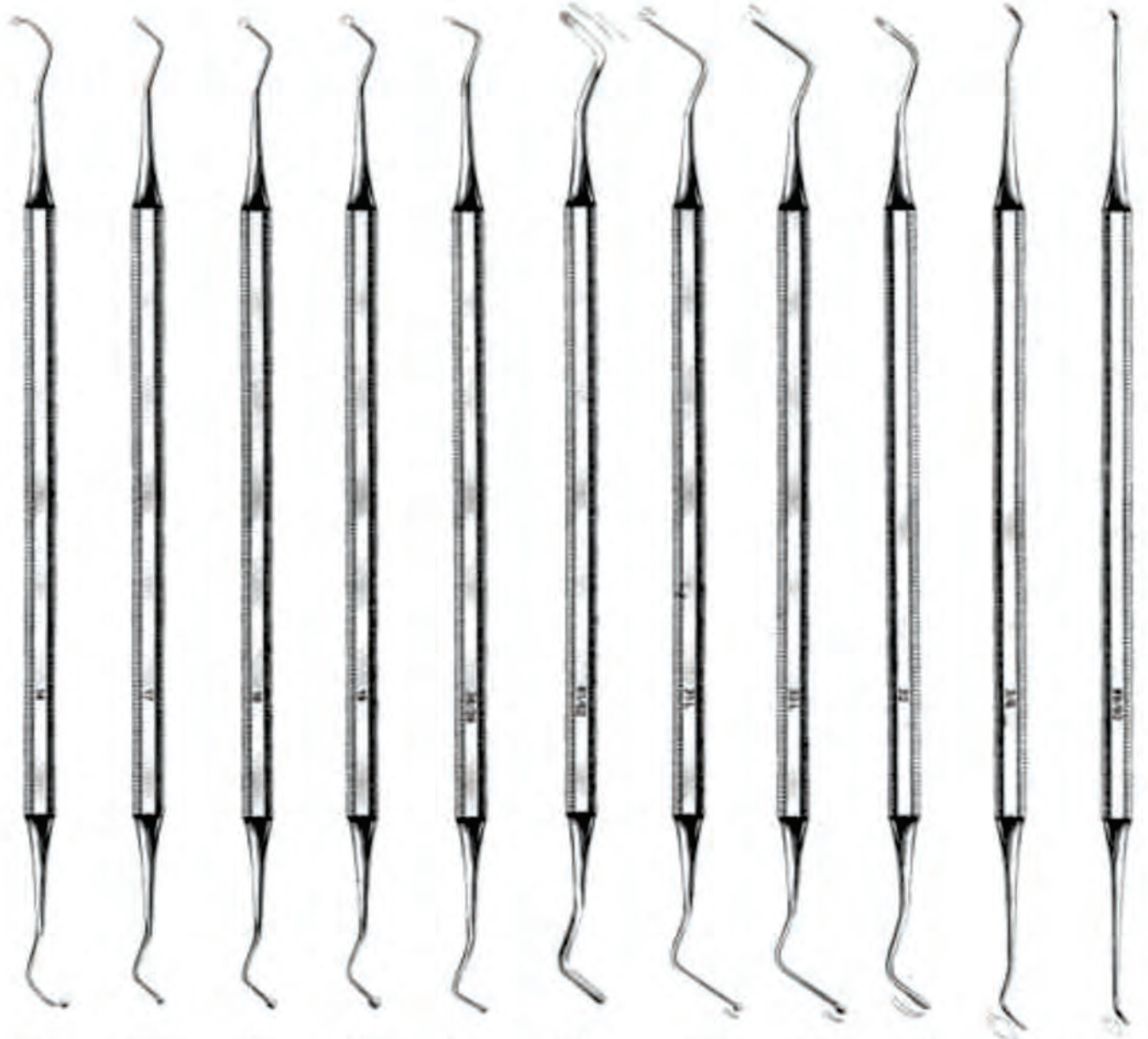

1744
No. 14

1745
No. 17

1746
No. 18

1747
No. 19

1748
No. 38/639

1749
No. 61/62

1750
No. 31L

1751
No. 33L

1752
No. 22

1753
No. 3/6

1754
No. 89/92



Excavators



1755
 1mm Discoid (10-7-14)

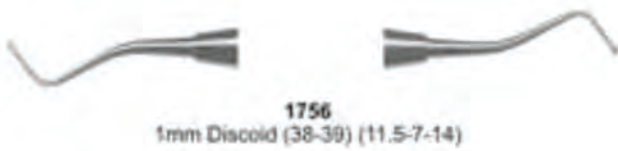

1756
 1mm Discoid (38-39) (11.5-7-14)



1757
 E2 Discoid (15-9-15)



1758
 1.5mm Discoid (15-8-14)



1759
 E3 Discoid (25-9-15)



1760
 2mm Discoid (20-9-14)



1761
 1.5mm Spoon (15-8-14)



1762
 E1 Discoid (12-9-15)



1763
 2mm Spoon (20-9-14)



1764
 17 Tear-Drop



1765
 19 Tear-Drop



1766
 18 Tear-Drop



1767
 20 Tear-Drop



Excavators, Explorer / Probes

Excavators



1768
31L



1769
31W



1770
33L



1771
32L



Explorers / Probes



1772
G16D-L



1773
Explorer No.2



1774
Explorer No.16



1775
16-23 Explorer



1776
16-17 Explorer



1777
DG16 Explorer



1778
(Heavy DG-16)





Explorers





Explorers

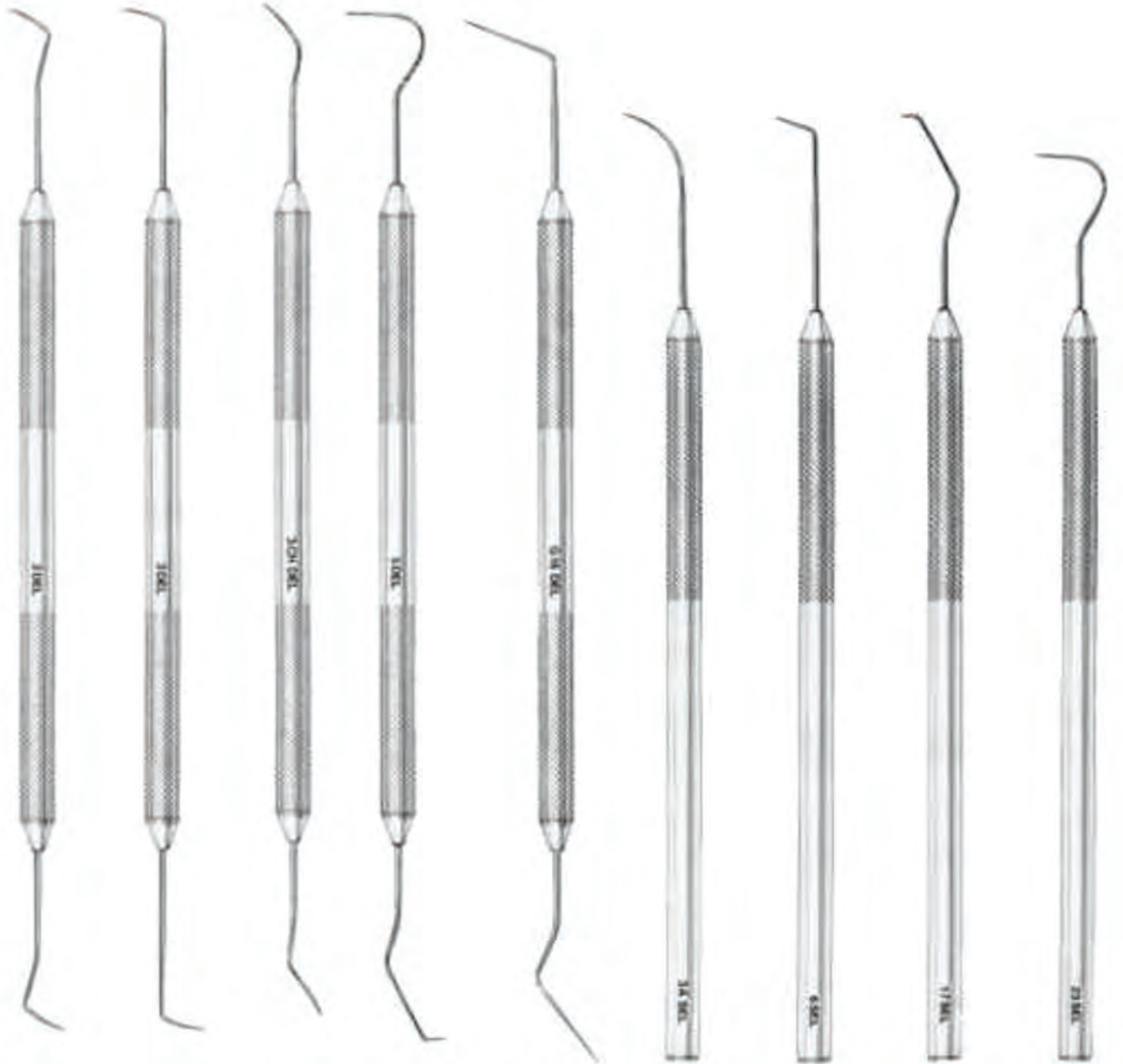

1790
No. 2D-L

1791
No. 3D-L

1792
No. 3CHD-L

1793
No. 5D-L

1794
No. G16D-L

1795
No. 3AS-L

1796
No. 6S-L

1797
No. 17S-L

1798
No. 23S-L



Explorer / Probe Combination



1799
Gt17 Probe/Explorer



1800
PE 1-23 Probe/Explorer



1801
Probe 0 / 23 Explorer (fine)



1802
Probs 1 / 23 Explorer



1804
Probe 4 / 23 Explorer



1803
Probe OW / 23 Explorer

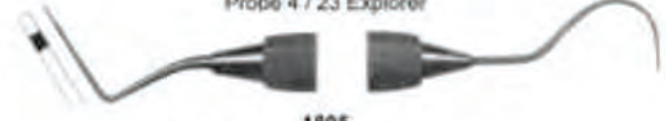

1805
Ball Tip Probe WHO / 23 Explorer

PROBES



1806
Gt18 Probe

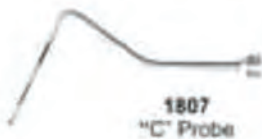

1807
'C' Probe



1808
X2 Probe

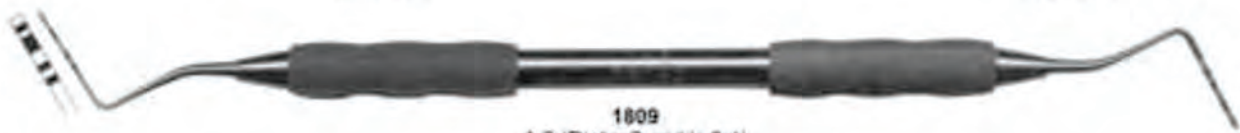

1809
1-2 (Probe 2 end is flat)



1810
1 UNC 15



1811
4 SE



Cord Packers, Hatchets, Hoes

CORD PACKERS



1812



1813
Fig. 1



1814
Fig. 2



1815
BLOOMFIELD
Fig. 2 (off angle)



1816
Fig. 1



1817
CSI-1 (slightly serrated on ends)

HATCHETS



1818
1mm (10-7-14)



1819
1.3mm (13-10-16)



1820
1.5mm (15-8-14)

HOES

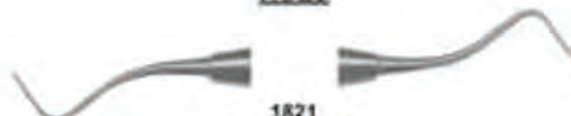

1821
1mm (10-8-16)



1822
LWH 18-19



1823
LWH 16-18



1824
LWH 20-21



P.K.Thomas waxing & Gracey Curettes Set



1825
P.K.Thomas 1



1826
P.K.Thomas 2



1827
P.K.Thomas 3



1828
P.K.Thomas 4



1829
P.K.Thomas 5

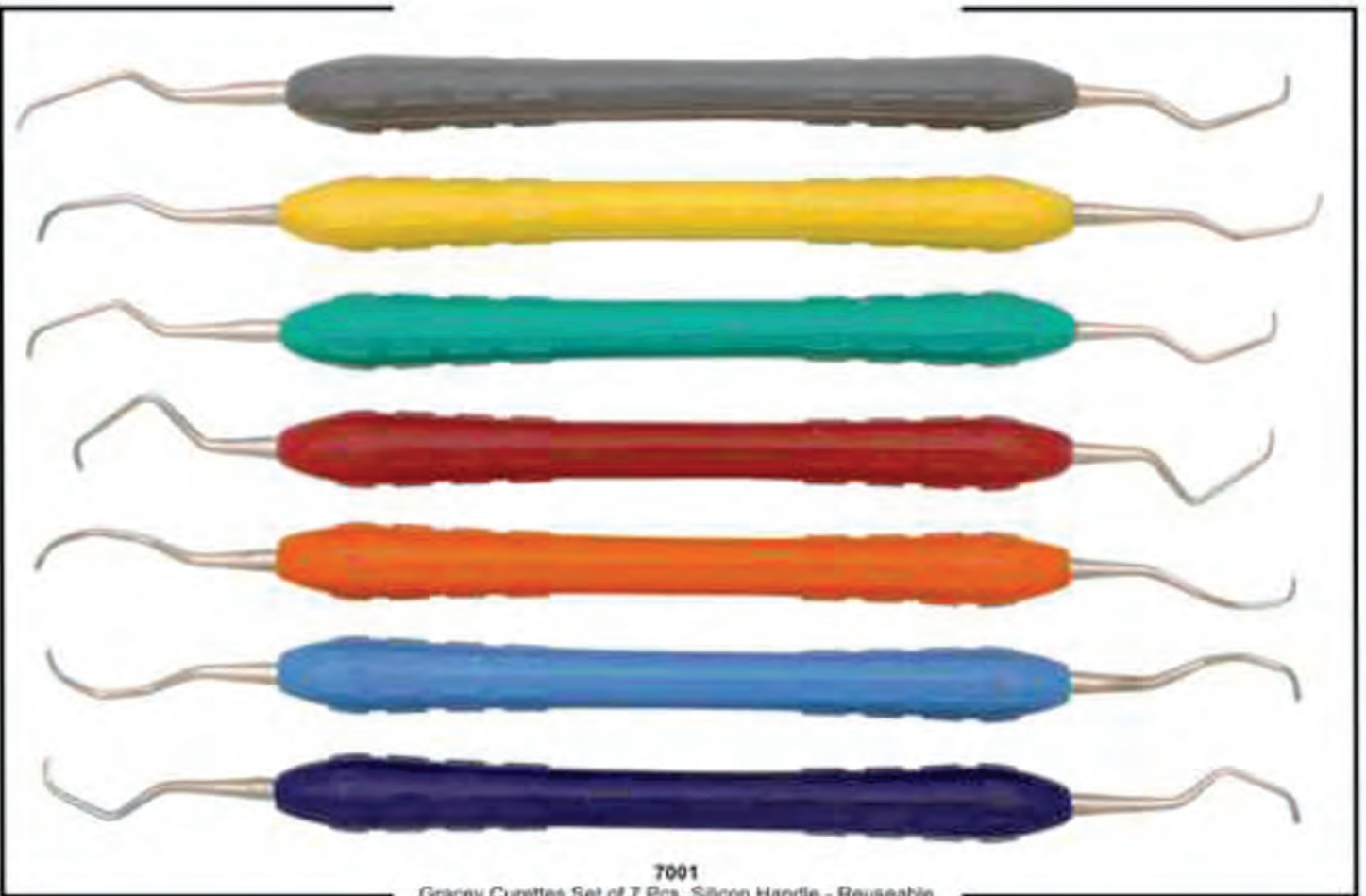

7001
Gracey Curettes Set of 7 Pcs, Silicon Handle - Reuseable



Amalgam Pluggers / Condensers / Applicators



1830
BEHRMAN (Fig. 1)



1831
BLACK (Fig. 1-2)



1832
MORQUETTE (Fig. 0/1)



1833
Black Action 11/12 Plugger



1834
Hollenback No. 1 Plugger



1835
Hollenback No. 2 Plugger



1836
Hollenback No. 3 Plugger

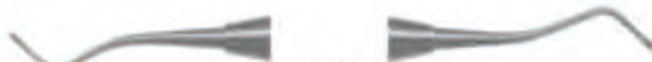

1837
Blacks 0-1 (1mm-1.5mm)



1838
Blacks 1-2 (1.5mm-2.5mm)



1839
Bodkin 1 (.7mm-1mm)



1840
Bodkin 2 (1.5mm-2mm)



1841
2.5mm-3mm



1842
Oregon 2



1843
7mm-1mm



1844
1mm-1.5mm



1845
1.5mm-2mm



1846
Oregon (Fig. 3)



1847
Oregon (Fig. 4)



1848
UP 12



1849
Applicator 1-2



1850
Birtles Applicator Spatula



1851
Birtles Applicator Spatula K



Placement Instruments, Stopping Stoppers, Plugg

Placement Instruments



Stopping Stoppers



Pluggers

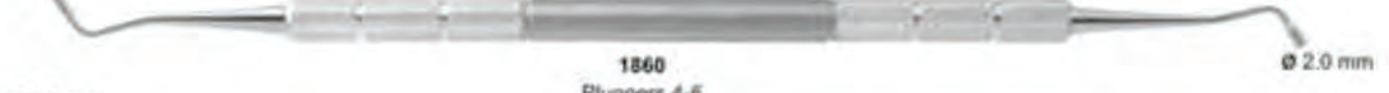
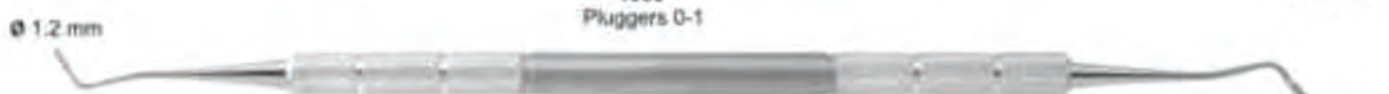

Section - 03

- Burnishers • Carvers • Chisels
- Composite Placements
- Filling Instruments • Curettes
- Disposable Instruments





Burnishers



1864
 Fig. 1



1865
 Fig. 28/29



1866
 Fig. 34



1867
 Fig. 27/29



1868
 Fig. 21B



1869
 ACORN
 Fig. 21



Burnishers



1870
21 Acorn



1871
Fig. 21B



1872
Fig. 2-34



1873
Fig. 21C



1874
Fig. 26-28



1875
Fig. 2-30



1876
Fig. 26-30



1877
Fig. 27-29



1878
PKT 1



1879
Fig. 27-30



1880
PKT 2



1881
Fig. 34T



1882
Fig. 3



1883
PKT 3



1884
PFI 21



1885
PKT 3P



1886
Pitts Pedo 19



1887
PKT 4

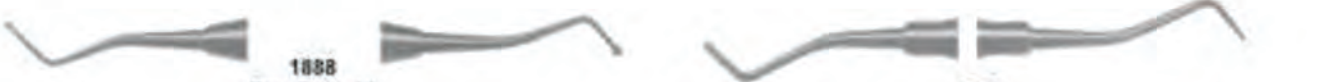

1888
Pitts Pedo 18



1889
PKT 5



Wax Carvers



1890
 HOLLENBACK
 Fig. 3



1891
 HOLLENBACK
 Fig. 3S



1892
 WARD
 Fig. 1



1893
 WARD
 Fig. 2



1894
 WALL
 Fig. 1



1895
 WALL
 Fig. 3



1896
 Fig. 3/6
 Cleoid/Discoïd



1897
 Fig. 89/92
 Cleoid/Discoïd



Carvers



1898
1.5mm Cleoid Discoid (Shown with GTX Finish)



1899
2mm Cleoid Discoid



1901
3mm Cleoid Discoid



1900
GOLLOBIN
Fig. 1



1902
HOLLENBACK
Fig. 1/2



1903
FRAHM
Fig. 2-3 (off-angle)



1904
HOLLENBACK
Fig. 3



1905
Interproximal 1



1906
THOMPSON (Fig. 3)
($\frac{1}{2}$ Hollenback Hoe & Wall 3)



1907
Interproximal 1



1908
THOMPSON (Fig. 5)
($\frac{1}{2}$ Hollenback Hoe & Tanner 5)



1909
Baum Interproximal



1910
THOMPSON (Fig. 8)
(3mm Cleoid & Wall 3)



1911
Sho A Carver



1912
THOMPSON (Fig. 9)
(Hollenback 3 & Wall 3)



1913
Thompson 2



1914
WARD
Fig. 2





Carvers, Chisels

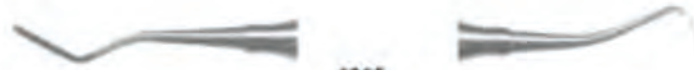

1915
Composite Interproximal



1916
TANNER
Fig. 5



1917
TANNER
Fig. 6



1918
THARP
Fig. 1



1919
THOMPSON
Fig. 1



1920
University of Minnesota
Fig. 1



1921
University of Minnesota
Fig. 2



1922
UPR
Fig. 1



1923
WALL
Fig. 3

Contour Carbide Carvers - Finishing



1924
Contour Carbide (Fig. 1-2)



1925
Cleoid Discoid



1926
Contour Carbide (Fig. 10-11)

Chisels



1927
1.5mm Bis-Angle (15-8-8)



1928
1.5mm Straight (15)



1930
1.5mm Wedelstaedt (15-15-3)



1929
1mm Wedelstaedt (10-15-3)



1931
2mm Wedelstaedt (20-15-3)



Composite Placement



1932
F-Type 1

1933
F-Type 2

1934
F-Type 3

1935
F-Type 4

1936
F-Type 5

1937
F-Type 6

1938
G-Type 1

1939
G-Type 2

1940
G-Type 3

1941
G-Type 4

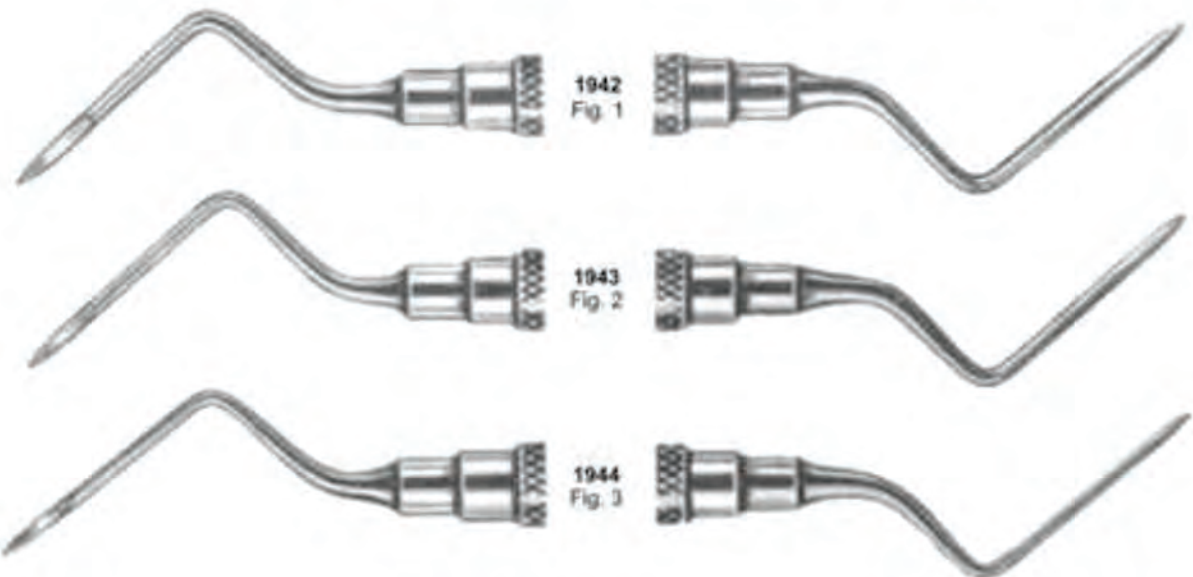

1942
Fig. 1

1943
Fig. 2

1944
Fig. 3



Composite Placement



1945
Fig. 2



1946
Fig. 3 (off-set blade)



1947
Fig. 4



1948
Fig. 5



1954
Fig. 12



1949
Fig. 6



1950
Fig. 7



1951
Fig. 8



1955
Fig. 15



1952
Fig. 9



1953
Fig. 11



1956
JORDAN
Fig. 2



1957
FREEDMAN
Fig. 1



1958
FREEDMAN
Fig. 2



1959
FREEDMAN
Fig. 3



1960
Dr. Dan



1961
SIMON
Fig. 2



K - Type

1962
K-Type 1



1963
K-Type 2



1964
K-Type 3



1965
K-Type 4



1966
K-Type 5



1967
K-Type 6 Carbide



Plastic Filling Instruments



1968
No.3

1969
No.4

1970
No.5

1971
LADMORE
Fig. 3

1972
WOODSON
Fig. 1

1973
WOODSON
Fig. 2

1974
WOODSON
Fig. 3

1975
W-3

1976
Gregg
4/5



Plastic Filling Instruments



1977
 Fig. 5-7



1978
 Fig. 1



1979
 Fig. 3



1983
 GLICK
 Fig. 1



1980
 Fig. 4



1984
 P8



1981
 Fig. 5-7



1985
 WOODSON
 Fig. 1



1982
 Fig. 8A



1986
 WOODSON
 Fig. 2



1987
 WOODSON
 Fig. 3

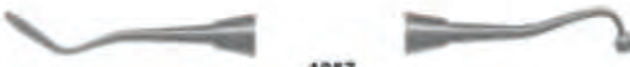



Curettes



1988
GRACEY
GC 1-2



1989
GRACEY
GC 3-4



1990
GRACEY
GC 5-6



1991
GRACEY
GC 7-8



1992
GRACEY
GC 9-10



1993
GRACEY
GC 11-12



1994
GRACEY
GC 13-14



Gracey Curettes



1995
G1-2



1996
G3-4



1997
G5-6



1998
G7-8



1999
G9-10



2000
G11-12



2001
G13-14



Curettes # 4 Handle

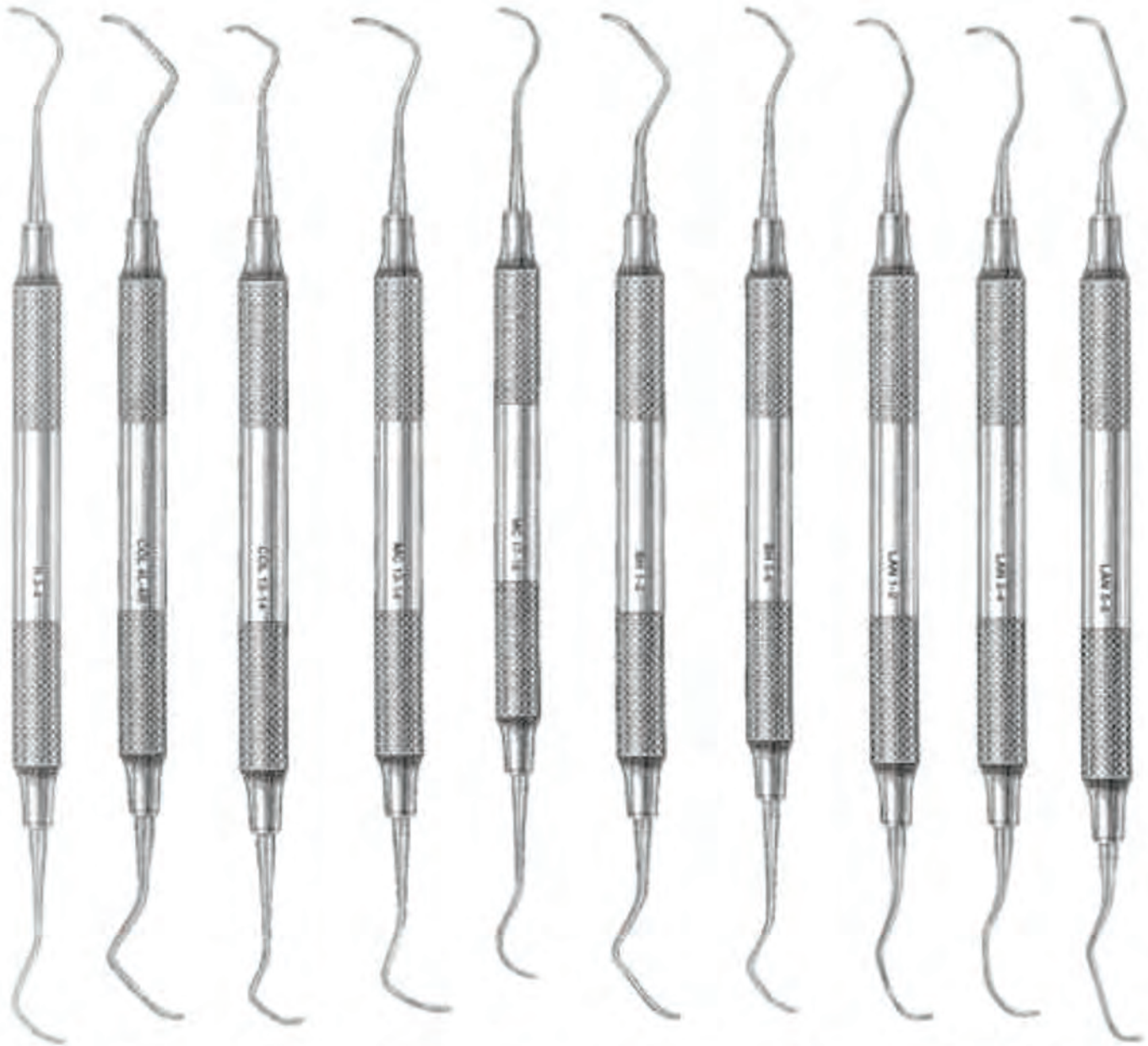

2002
 RULE
 3-4

2003
 COLUMBIA
 4R-4L

2004
 COLUMBIA
 13-14

2005
 MCCALLS
 13-14

2006
 MCCALLS
 17-18

2007
 BARNHART
 1-2

2008
 BARNHART
 5-6

2009
 LANGER
 1-2

2010
 LANGER
 3-4

2011
 LANGER
 5-6



Curettes

COLUMBIA CURETTES



2012
4L-4R

2013
13-14

2014
2L-2R

MCCALLS CURETTES



2015
13-14

2016
135-145

2017
17-18

2018
17S-18S



Curettes

GOLDMAN FOX



2019
GF1 Universal Scaler



2020
GF2 Curette



2021
GF3 Curette



2022
GF4 Curette



2023
GF5 Hoe



2024
GF6 Hoe



Curettes

GOLDMAN FOX



2025
GF 7 Knife



2026
GF 8 Spear Knife



2027
GF 9 Knife Scaler



2028
GF 11 Spear Knife



2029
GF 21 Sharp Spoon /
Small Scaler



Knives, Interproximal Files



2030
Kirkland 15 / 16



2031
Ordan 1 / 2



2032
Buck 3 / 4



2033
Buck 5 / 6

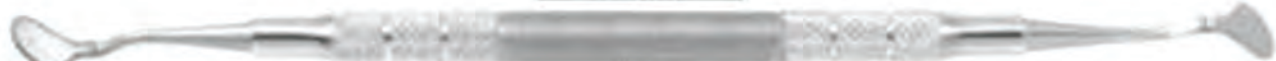

2034
Goldman-Fox 7



2035
Goldman-Fox 8



2036
Goldman-Fox 9



2037
Goldman-Fox 11



2038
CK 3 (Crane)

Interproximal Files



2039
Sugaman 1S-2S



2040
Sugaman 3S-4S



2041
Schluger 9 -10



2042
Buck 11 - 12



Curettes, Root Planning Curettes



2043
COLUMBIA (2L-2R)



2044
MCCALL (13-14)



2045
MCCALL (17S-18S)

Root Planning Curettes



2046
Root Plane (1-2)



2047
Root Plane (5-6)



2049
Root Plane (11-12)



2048
Root Plane (7-8)



2050
Root Plane (13-14)



2051
Petite (1-2)



2052
Petite (11-12)



2053
Petite (5-6)



2054
Petite (13-14)



Curettes



2055
BARNHART (1-2)



2056
BARNHART (5-6)



2065
COLUMBIA (4L-4R)



2057
GRACEY (1-2)

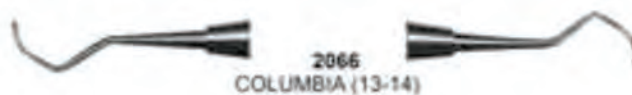

2066
COLUMBIA (13-14)



2058
GRACEY (3-4)



2067
LANGER (1-2)



2059
GRACEY (5-6)



2068
LANGER (3-4)



2060
GRACEY (7-8)



2069
LANGER (5-6)



2061
GRACEY (9-10)



2070
MCCALL (13-14)



2062
GRACEY (11-12)



2071
MCCALL (13S-14S)

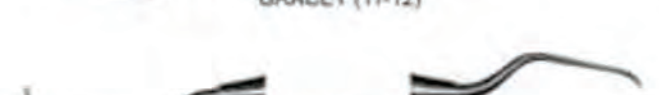

2063
GRACEY (13-14)

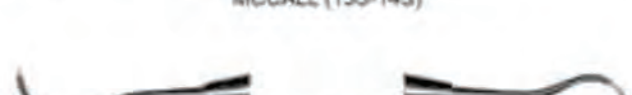

2072
MCCALL (17-18)

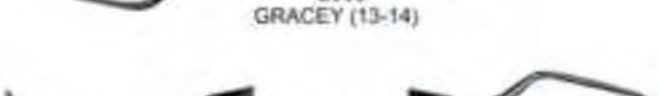

2064
GRACEY (2L-2R)

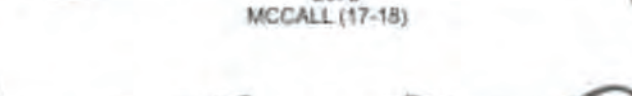

2073
MCCALL (17S-18S)



2074
RULE (3-4)

Section - 04

- Cement Instruments • Spatulas
- Knives • Bone Currettes & Files
- Bone Chisels • Bone Mallets
- Crown Remover
- Implant Instruments





Dental Products

Silicon Handles-Reusable



2075 2076 2077 2078 2079 2080 2081 2082 2083 2084 2085



2086 2087 2088 2089 2090



Wax, Porcelain & Cement Instruments

Comfort Grip Vinyl - Covered Insulating Handles





Wax, Porcelain & Cement Instruments

P.K. THOMAS



2101
PKT 1

2102
PKT 2

2103
PKT 3

2104
PKT 4

2105
PKT 5

Set of 5 instruments

WAX CARVERS

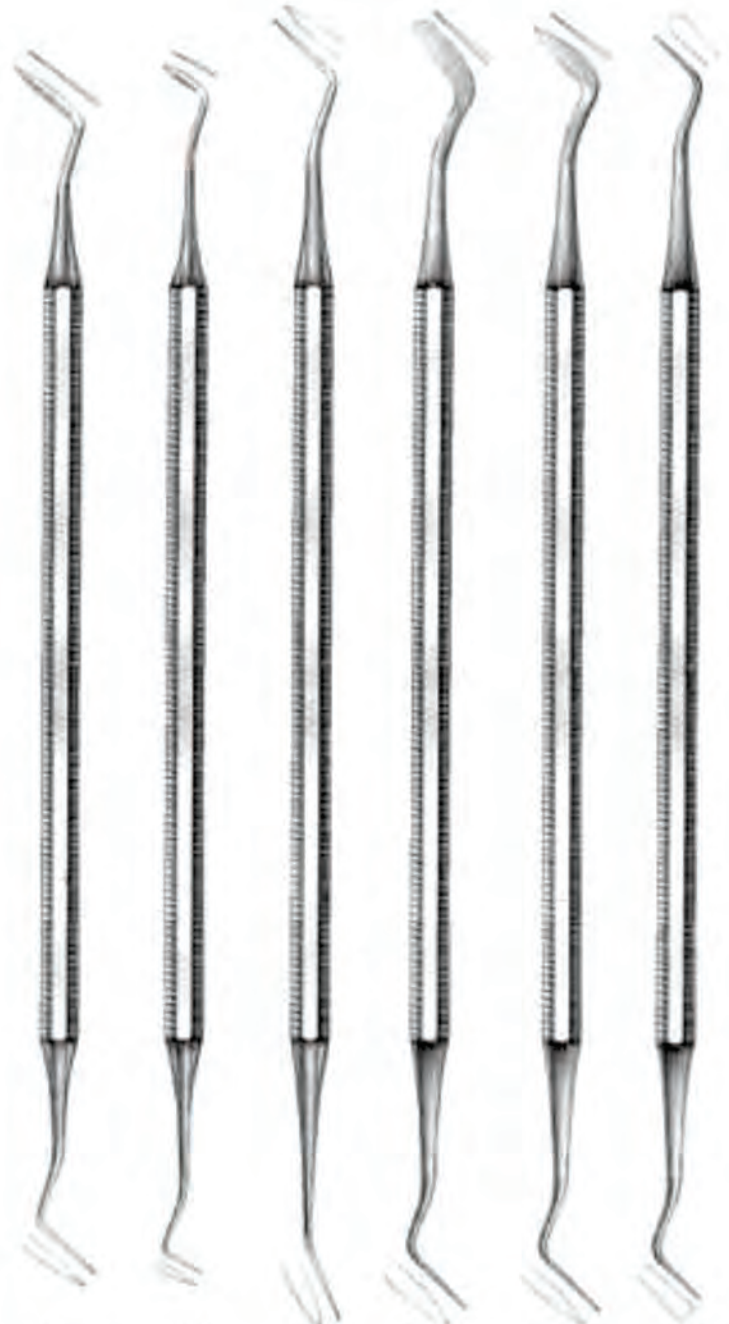

2106
Hollenback 3

2107
Hollenback 3S

2108
WARD 1

2109
WARD 2

2110
WALL 1

2111
WALL 3



Wax & Modeling Carvers, Cement Spatulas

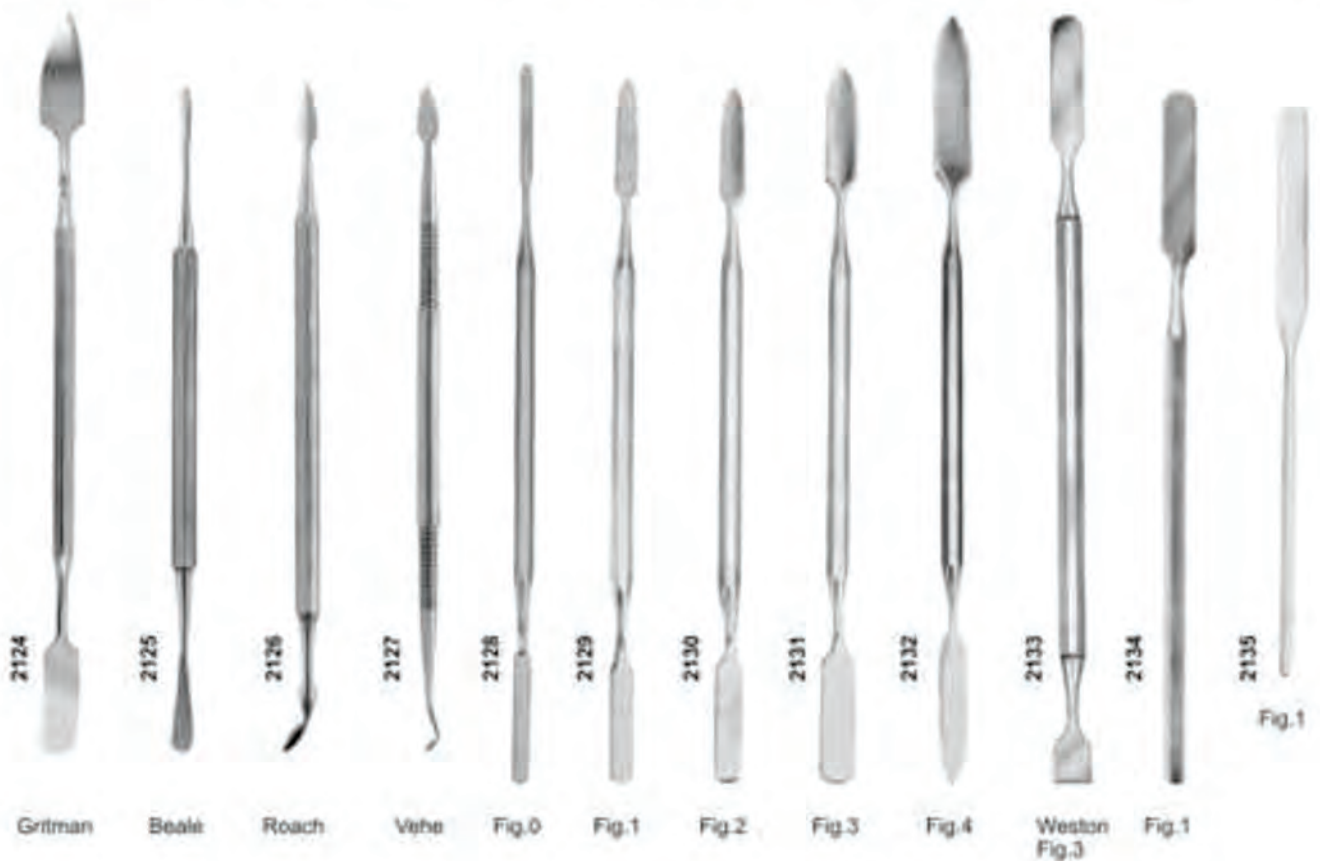
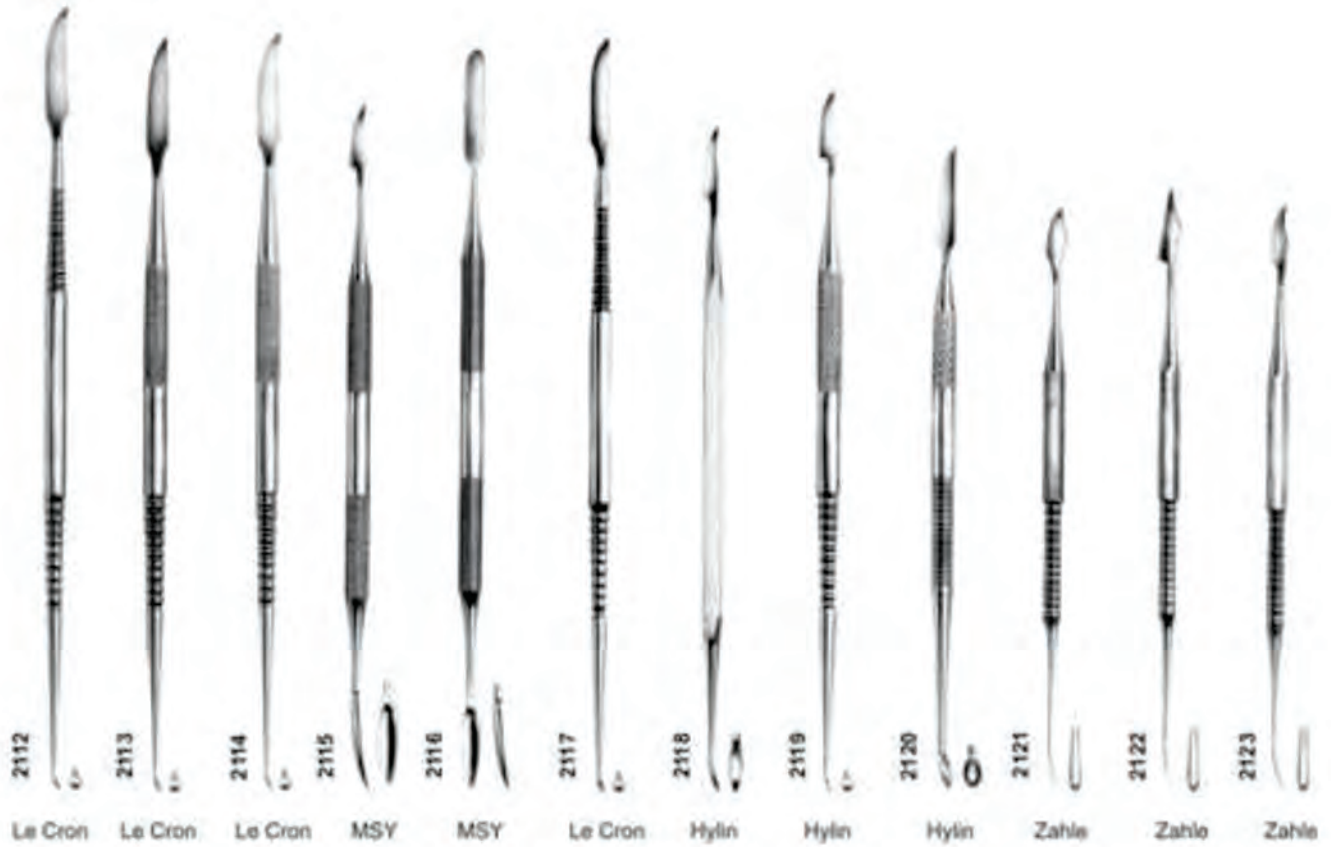



Wax, Porcelain & Cement Instruments

WAX & PORCELAIN CARVERS



2136
 LECRON
 Inlay



2137
 REEVES



2138
 VEHE
 Wax



2139
 ROACH
 Wax



2140
 W-31



2141
 W-5



2142
 W-7



2143
 W-7A



2144
 W-7G

WAX SPATULAS



Cement Spatulas



2145
 AGATHE



2146
 C-7



2147
 C-5



2148
 C-313



2149
 C-24A Rigid



2150
 C-24 Flexible



2151
 C-24 Flexible



2152
 24



2153
 A6



2154
 7 Wax



2155
 26



2156
 All Metal Spatulas with High Polish
 Stainless Steel Blade



2157
 31



Spatulas



2158
Fig. 1
18.5 cm



2159
Fig. 2
18 cm



2160
Fig. 3
18.5 cm



2161
Fig. 4
19.5 cm



2162
Fig. 5
21.5 cm



2163
Fig. 6
20.5 cm



Spatulas



2164
Fig. 7
19.5 cm



2165
Fig. 8
20 cm

2166
Fig. 9
22.5 cm



Files, Hoes & Knives

FILES

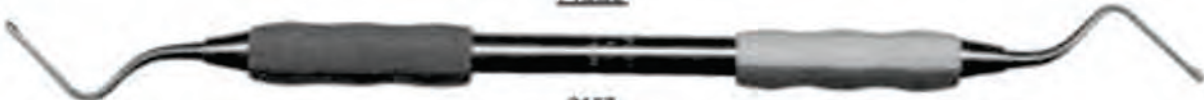

2167
Hirschfeld 3-7



2168
Hirschfeld 5-11



2169
Hirschfeld 9-10



2170
Orban 10-11

HOES

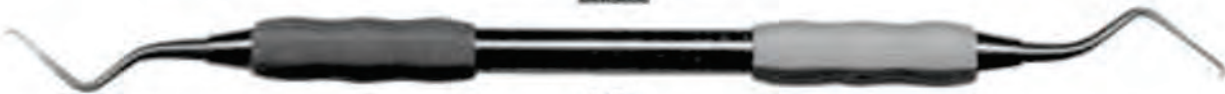

2171
Orban 6-7



2172
Orban 8-9



2173
UWH 18-19



2174
UWH 15-18



2175
UWH 20-21



2176

KNIVES



2177
Orban Knife (1-2)



2178
1 SE



2179
2-3



2180
Kirkland 13-13L



2181
Knife Orban 1-2 TT DEO



Wax Knives



2182
 Fahnenstock
 Fig. 1
 12,5cm

2183
 Fahnenstock
 Fig. 2
 17cm

2184
 Lessmann
 Fig. 1
 12,5cm

2185
 Lessmann
 Fig. 2
 17cm

2186
 Con scodellino
 Fig. 1
 12,5cm

2187
 Con scodellino
 Fig. 2
 17cm

2188
 Ermert

2189
 Ermert



Wax Knives & Plaster Knives



2190
 18 cm
 7 1/8"



2191
 18 cm
 7 1/8"



2192
 17 cm
 6 3/4"
 Gritman



2193
 17 cm
 6 3/4"
 Madison



2194
 Fig. 1
 17 cm



2195
 22 cm
 8 3/4"



2196
 22 cm
 8 3/4"



2197
 Gritman
 Fig. 2
 17 cm



2198
 Fig. 3
 16 cm



2199
 Fig. 4
 16 cm



Crane-Kaplan, Chisels

CRANE-KAPLAN



2200
Ck1
Pocket Marker



2201
Ck2
Pocket Marker



2202
Knife



2203
Dissector



2204
Scaler

OCHSENBEIN



2205
Ochsenbein
Fig. 1



2206
Ochsenbein
Fig. 2



2207
Ochsenbein
Fig. 4



Split Chisel Set



2208
Split Chisel
6 mm Curved



2209
Split Chisel
6 mm Straight



2210
Split Chisel
4 mm Curved



2211
Split Chisel
4 mm Straight



Bone Currettes

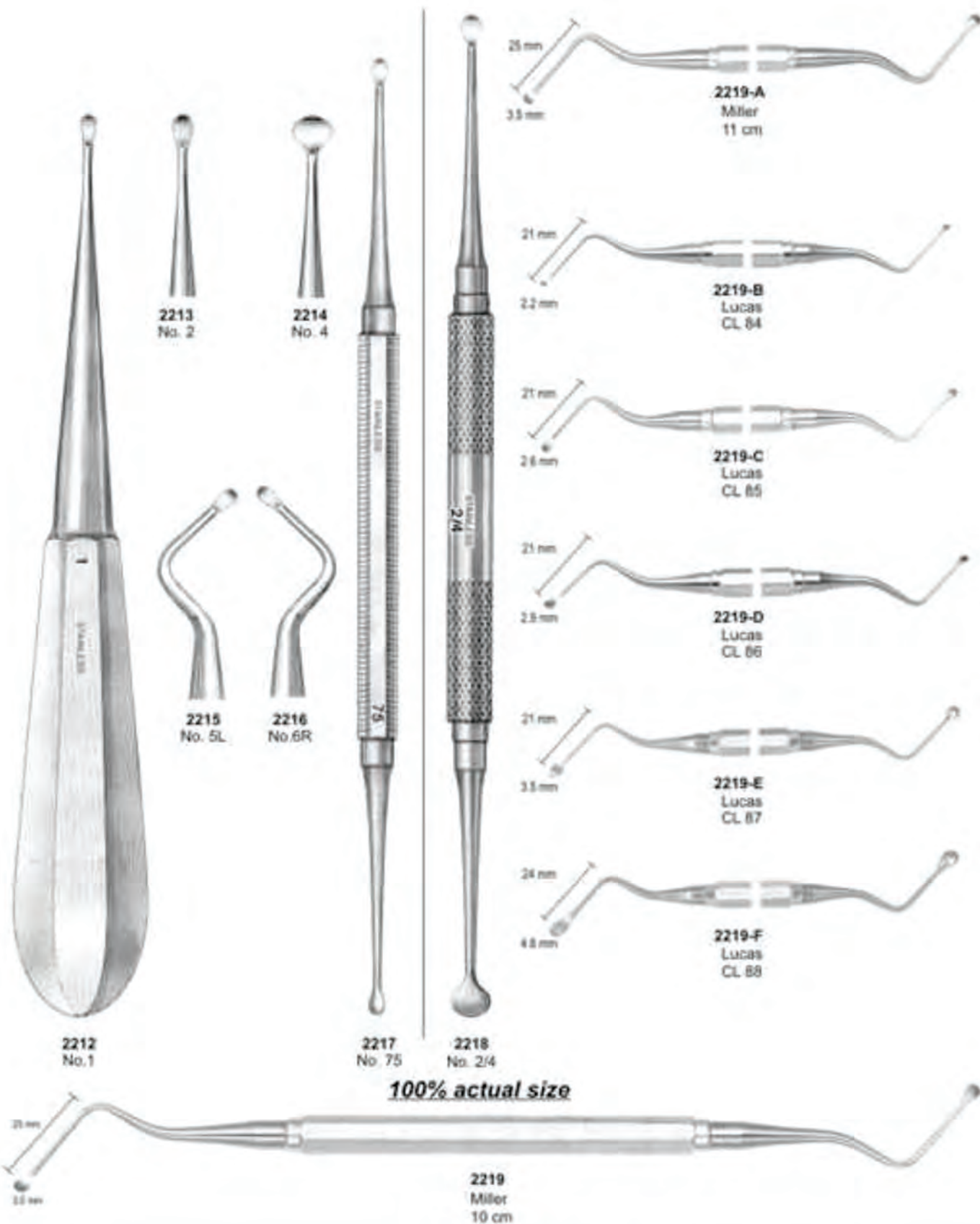



Bone Files



2220
 No. 10



2221
 No. 33



2222
 MILLER
 No. 33



2223
 MILLER
 No. 64





Bone Files



2224
 HOWARD
 No. 12



2225
 HOWARD
 No. 12A



2226
 HOWARD
 No. 12CA



2227
 POLOKOFF
 No. 1





Bone Chisels

GARDNER



2228
GARDNER
No. 1

2229
GARDNER
No. 2

2230
GARDNER
No. 5

2231
GARDNER
No. 5R

WAKEFIELD



2232
WAKEFIELD
No. 1W

2233
WAKEFIELD
No. 2W



Bone Chisels, Bone Mallets

Bone Chisels and Gouges

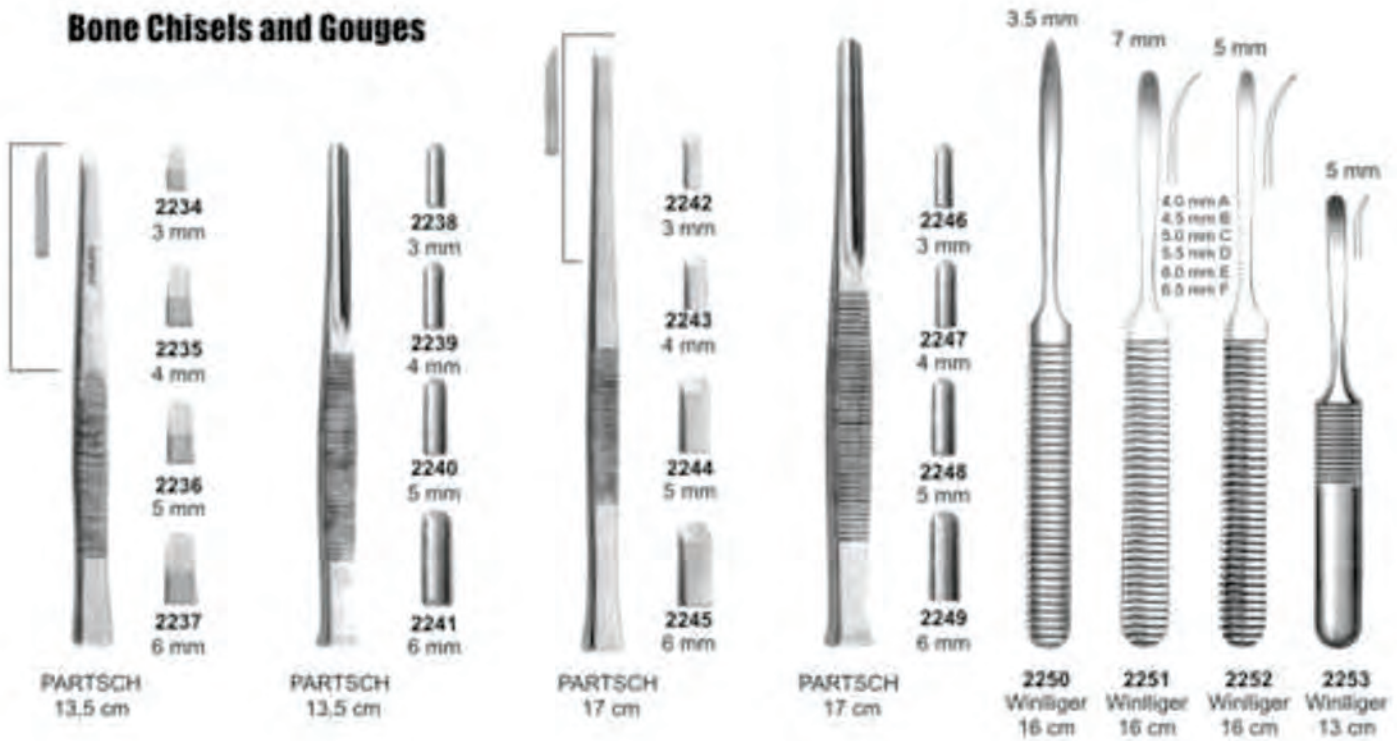

Martelli chirurgici Mallet





Crown Removers

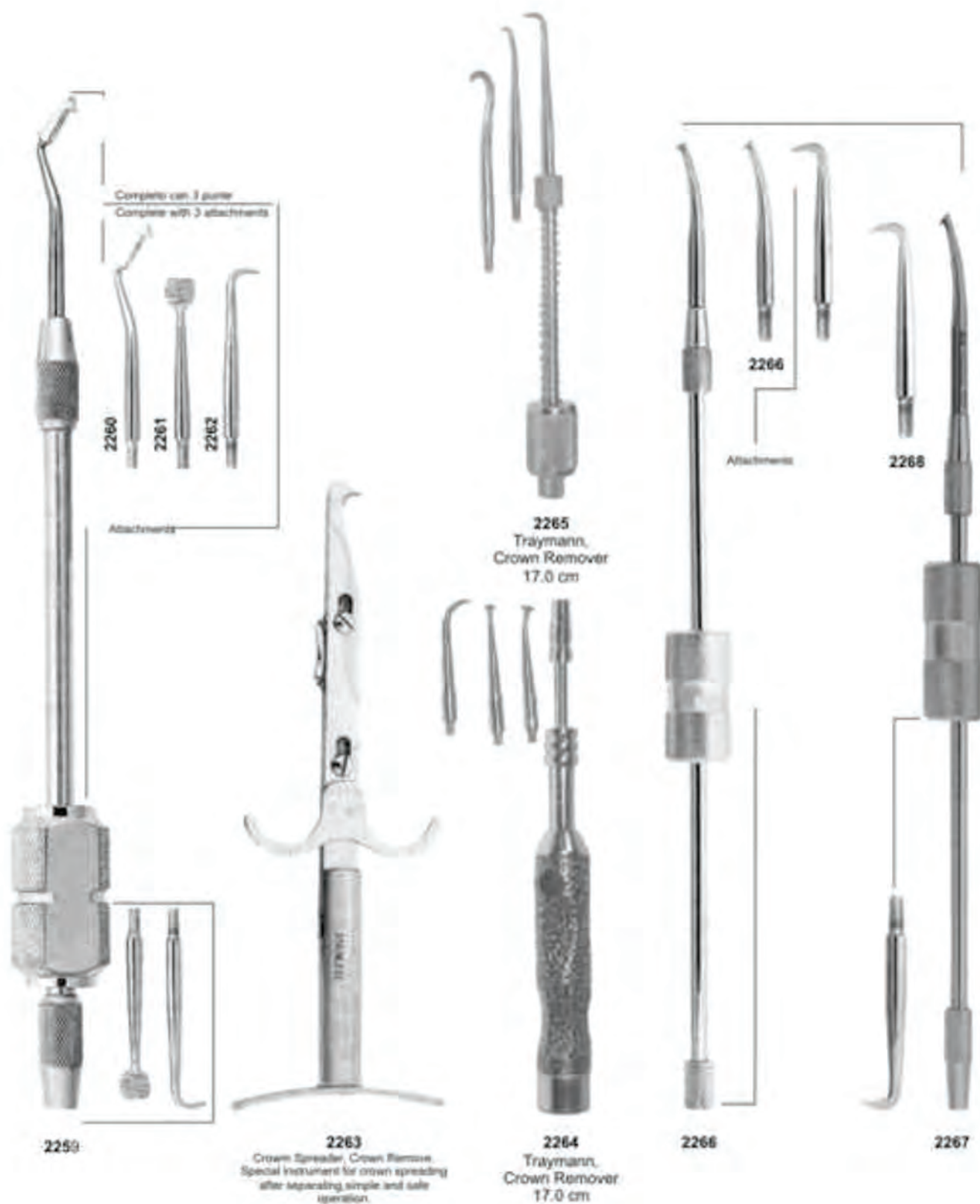



Crown Instruments

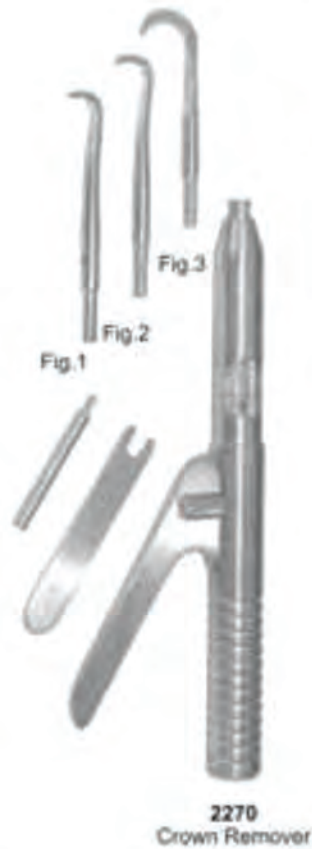



Crown Instruments



2282
 Plaster Shear
 210 mm



2283
 Crown Removing Plier
 14 cm



2284
 MONTFORT
 18 CM



2285
 BOHM
 16 cm



2286
 Telescope Crown
 Plier, Diamond coated
 13.0 cm



2287
 Telescope Crown
 Plier, Diamond coated
 13.0 cm



2288
 Telescope Crown Plier
 13.0 cm gerieften Maul
 15.0 cm gerieften Maul
 13.0 cm gelatts Maul
 15.0 cm gelatts Maul



2289
 Telescope Crown
 Plier, Fine
 15.0 cm



Implants Instruments

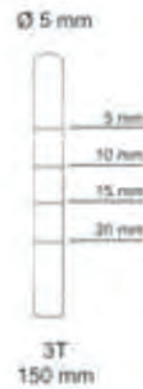
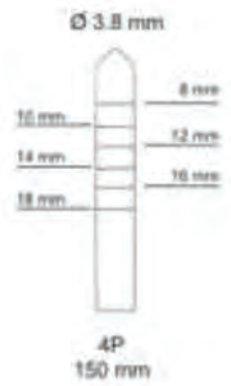



Implants Instruments



2292
Fig. 1B
165 mm



Ø 2 mm
1B



Ø 3 mm
2B



Ø 3.3 mm
3B



Ø 4 mm
4B



Ø 5 mm
5B

6 mm
8 mm
11 mm
15 mm



Ø 2 mm
1BCC



Ø 3 mm
2BCC



Ø 3.3 mm
3BCC

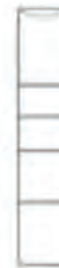

Ø 4 mm
4BCC

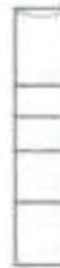

Ø 5 mm
5BCC

6 mm
8 mm
11 mm
15 mm



2293
Fig. 1
155 mm



Ø 2 mm
1RRT



Ø 3 mm
2RRT



Ø 3.3 mm
3RRT

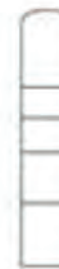

Ø 4 mm
4RRT



Ø 5 mm
5RRT

6 mm
8 mm
11 mm
15 mm



Ø 2 mm
1RRC



Ø 3 mm
2RRC



Ø 3.3 mm
3RRC

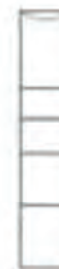

Ø 4 mm
4RRC



Ø 5 mm
5RRC

6 mm
8 mm
11 mm
15 mm



Implants Instruments

Endo guns for retrograds.



2294
 Ø 1.2 mm
 130 mm

Ø 1.2 mm
 Curved

Carry any mixed materials to perforations, apical or difficulty to access sites.



2295
 Ø 1.8 mm
 130 mm

Curved



Bone Injectors



2296
 Ø 2.5 mm
 150 mm



2297
 Ø 4.4 mm
 150 mm



2298
 Ø 7 mm
 150 mm



2299
 Ø 2.5 mm
 150 mm



2300
 Ø 4.4 mm
 150 mm



Bone wall

2301
 Ø 35 mm
 h 35 mm



2302
 Grinders for autogenous



2303
 Bone Mill Forcep
 17.0 cm



Suction Tubes, Bone Pluggers & Rongeurs

Suction Tubes



Bone Pluggers



Kerrison Rongeurs



- (1.5 mm inside) 2311
 - (2.0 mm inside) 2312
 - (3.0 mm inside) 2313
 - (4.0 mm inside) 2314
 - (4.5 mm inside) 2315
- 16.5 cm

- (1.0 mm inside) 2316
 - (2.0 mm inside) 2317
 - (2.50 mm inside) 2318
- 16.5 cm



Implants Instruments



2319
Fig. 1
170 mm

2320
Fig. 2
175 mm

2321
Fig. 3
170 mm

2322
LUCAS
Fig. 88
170 mm

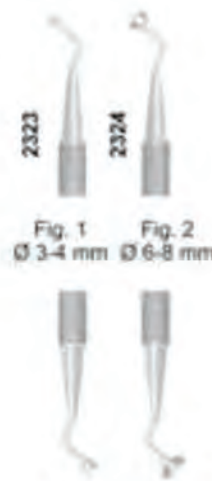

2323 Fig. 1
Ø 3-4 mm

2324 Fig. 2
Ø 6-8 mm

Bone Compactors.

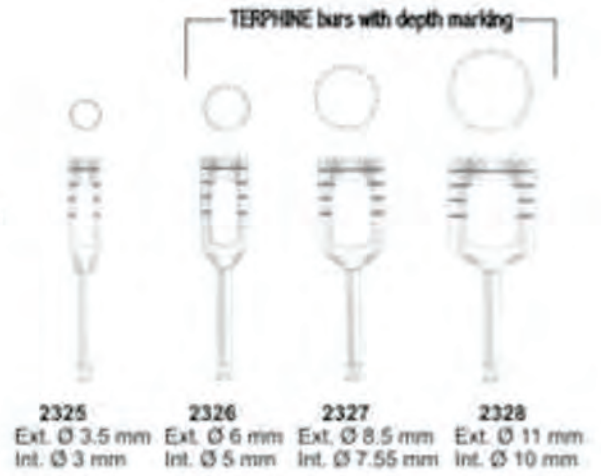

2325
Ext. Ø 3.5 mm
Int. Ø 3 mm

2326
Ext. Ø 6 mm
Int. Ø 5 mm

2327
Ext. Ø 8.5 mm
Int. Ø 7.55 mm

2328
Ext. Ø 11 mm
Int. Ø 10 mm

Sinus lift Instruments



2329
Fig. 1

2330
Fig. 2

2331
Fig. 3

2332
Fig. 4

2333
Fig. 5

2334
Fig. 6

2335
Fig. 7

2336
Fig. 8

2337
Fig. 9



Suction Tubes

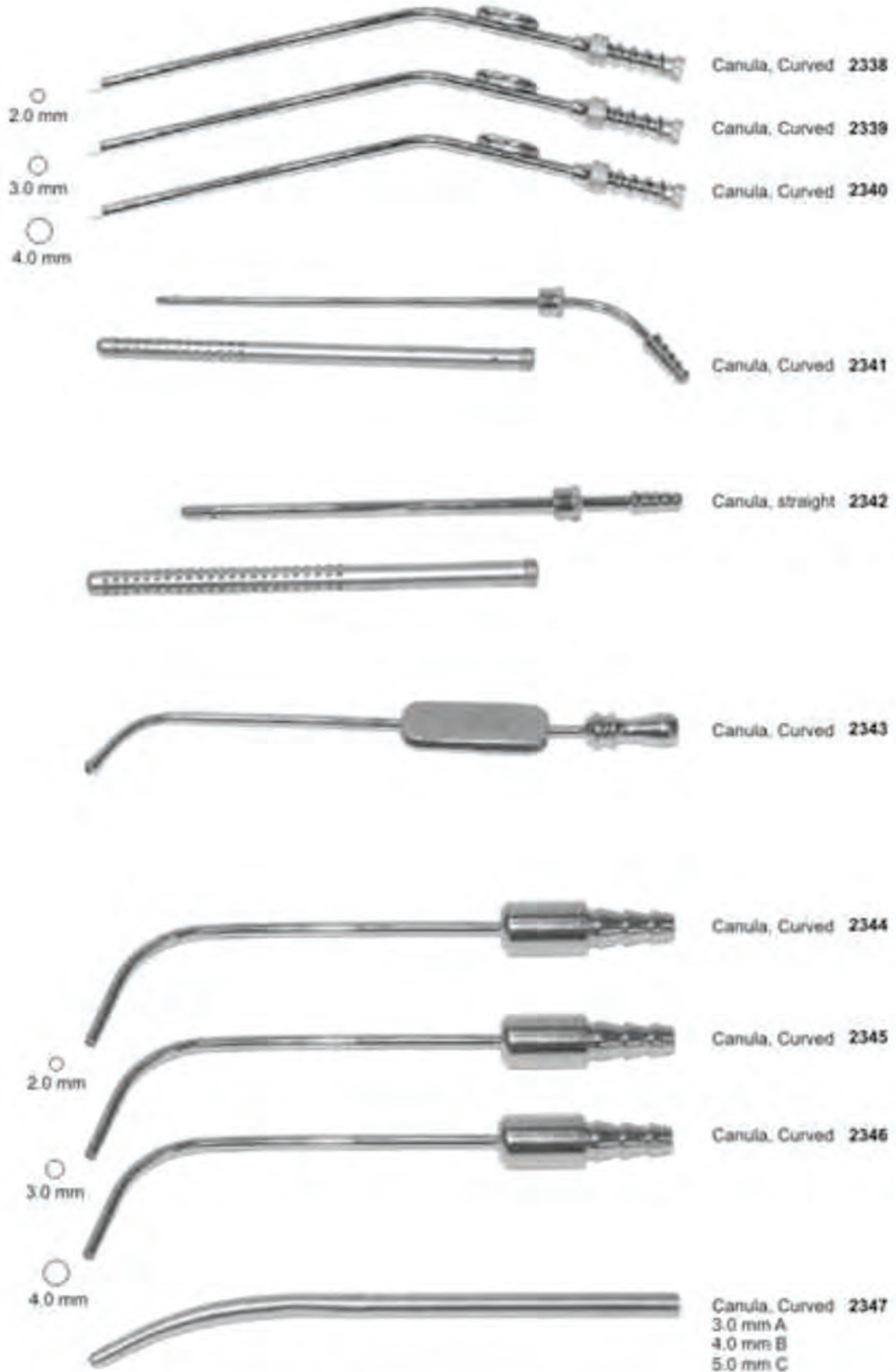



Measuring Instruments



2348
BOLEY Gauge



2349
ZURICHER
130 mm



2350
VERNIER
12 cm



2351
VERNIER



2352
VERNIER Gauge



2353
VERNIER Gauge



2355
Finger Ruler



2354
LWANSON
Crown Gauge



2356
LWANSON
Crown Gauge



2357
Sliding Gauge
10 cm



2358
Spring Bow Divider
6" Radius



2359
VERNIER
Gauge



2360
ALBEE



2361
Height Gauge
Wick Type



Bone Gauge & Measuring Instruments



2362
Bone Gauge



2363
Bone Caliper
15 cm



2364
Castroviejo



2365 A
Castroviejo
Curved



2365 B
Straight



2366 C
Castroviejo
Straight

2366 D
Curved



2367
Gauge



2368
Castroviejo
Straight

2369
Curved



2370
Castroviejo
Straight

2371
Curved



2373
Boone - Gauge



2372
Castroviejo

2374 **2375**
Curved Straight



2376
Bracket Gauge. Ant/Post



Amalgam Guns & Carriers



2377
 Medium-Large
 20 cm



2378
 Medium-Jumbo
 20 cm



2379
 Large-Jumbo
 20 cm



2380
 Jumbo-Jumbo
 20 cm



2381
 Regular-Jumbo
 Silicon Grip
 20 cm

Ø2 mm



2382
 Medium
 15.5 cm

Ø2.5 mm



2383
 Large
 15.5 cm

Ø3 mm



2384
 Jumbo
 15.5 cm



2385
 145 mm



2386
 130 mm



Ø2 mm



Ø2 mm
2387
 Straight
 15 cm



Ø2 mm
2388
 15 cm



2389
 15 cm
 90°



2390
 Amalgam Well
 Non Skid Base
 Ø3.5 mm



Retainers, Bands, Strip Holder Clips, Napkin Holder

Retainers



2391
No. 1

2392
No. 8

2393
No. 9

"Tofflemire" Type Retainers

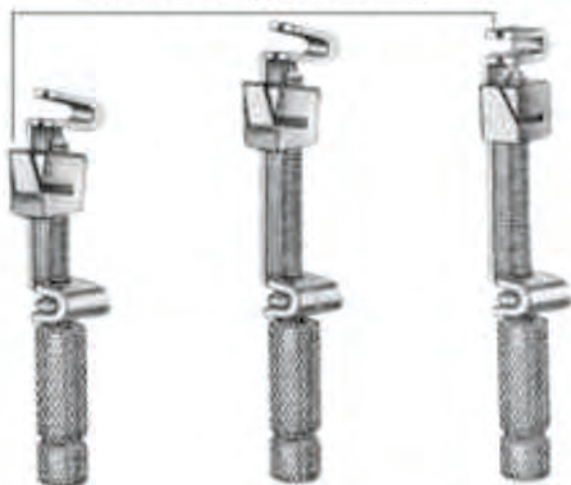

2394
JUNIOR-CA

2395
SENIOR-CA

2396
UNIVERSAL

Tofflemire Bands

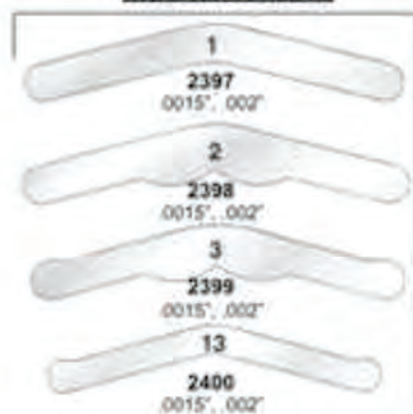

1

2397
.0015", .002"

2

2398
.0015", .002"

3

2399
.0015", .002"

13

2400
.0015", .002"

2401
X-Ray Holder
Small



Set of 10
2402
Film Hanger

Napkin Holders



2403
BALL CHAIN

2404
NON-CHILL
Clear Plastic

Strip Holders



2408
Strip Holder Clip
90°

2409
Strip Holder Clip
45°

2405
Finger Protector
Small

2406
Medium

2407
Large



Rubber Dam Instruments



2410
IRORY
Light weight, 170 mm



2411
BREWER
175 mm



2412
BREWER
175 mm



2413
WHITE
175 mm



2414
IVORY
170 mm



2415
AINSWORTH
Rubber Dam Punch
170 mm



2416
AINSWORTH
Rubber Dam Punch
170 mm



2417
AINSWORTH
Rubber Dam Punch
170 mm

Articulating Paper Forceps



2421
MILLER
Articulating
Forceps
15 cm



2422
MILLER
Articulating
Forceps
15 cm



2418
'IV' Type
Rubber Dam Punch
160 mm



2419
Plastic Rubber Dam
Frame 242



2420
Rubber Dam Holder
Stainless Steel Pins



Rubber Dam Clamps

LOWER MOLARS



2423
76D-W3



2424
76D-3



2429
76D-7A



2430
76D-7



2435
76D-12A



2436
76D-13A



2441
76D-26



2442
76D-28



2445
76D-W6A



2446
76D-6A



2447
76D-10



2448
76D-11



2451
76D-24



2452
76D-25

UPPER MOLARS



2425
76D-4



2426
76D-5



2431
76D-8



2432
76D-28N



2437
76D-30



2438
76D-31



2443
76D-201



2444
205

MOLARS



2449
76D-14



2450
76D-118



2453
76D-27



2454
76D-56



2455
76D-14A

PREMOLARS



2427
76D-0



2428
76D-1



2433
76D-2A



2434
76D-2



2439
76D-27N



2440
76D-29

ANTERIOR



2456
76D-00



2457
76D-1A



2458
76D-9



2459
76D-212



Aspirating Syringes

4969/CO



4969/F



4969/CV



2460
ml 1,8
EU



2461
ml 1,8
EU/AM



2462
ml 1,8
EU/AM



2463
Fig. 1
ml 1,8
EU



2464
Fig. 1
ml 1,8
EU



2465
SS INOX
All inox & autoclavable
black plastic handle
passive automatic
aspiration.



2466
Fig. 1
ml 1,8
EU/AM



2467
Fig. 1
ml 1,8
EU/AM



2468
Fig. 1
ml 1,8
EU/AM



2469
ml 1,2
EU/AM



Syringes

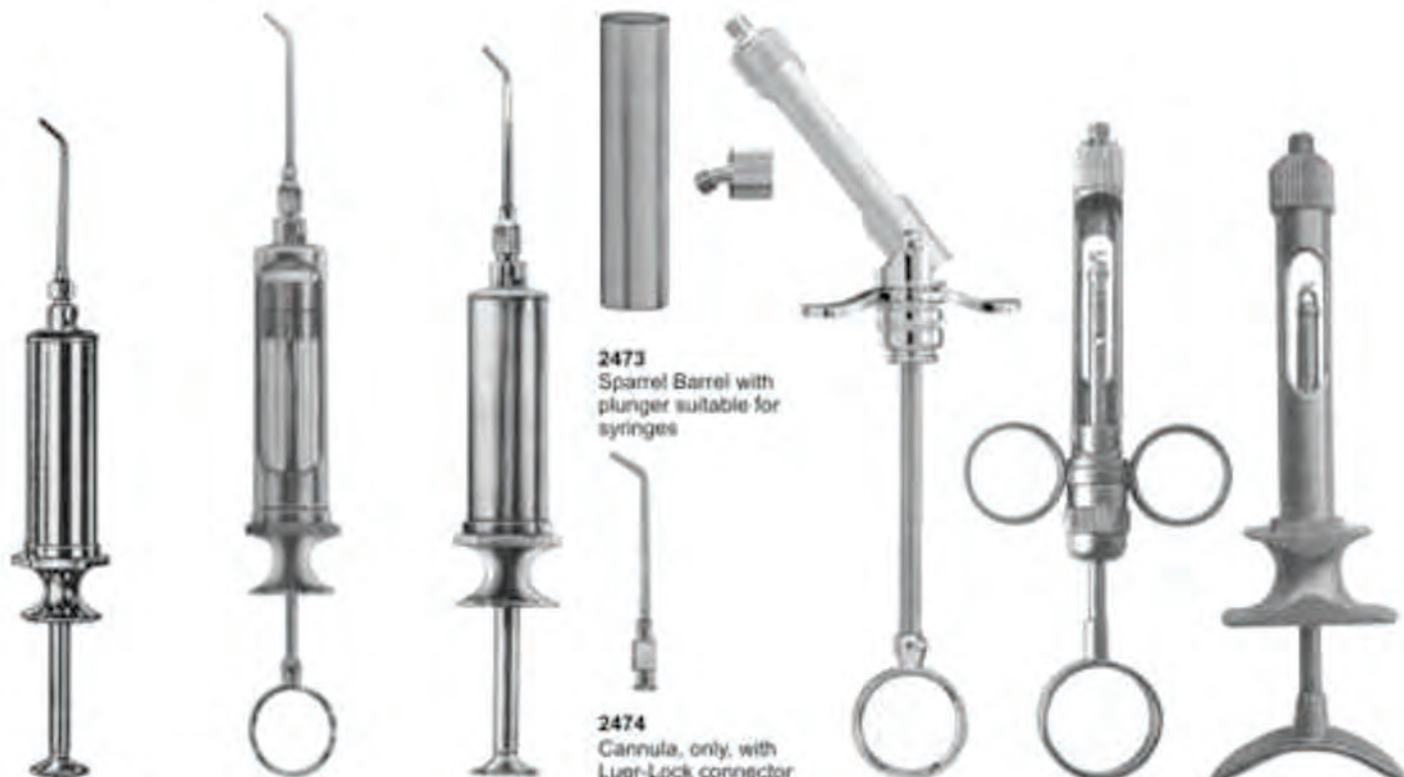

2470

Water Syringe
complete with
1 cannula (Luer-Lock)

2471

Water Syringe
complete with
1 cannula (Luer-Lock)

2472

Metal Water Syringe
self-filling, with 1
cannula (Luer-Lock)

2473
Sparrel Barrel with
plunger suitable for
syringes

2474
Cannula, only, with
Luer-Lock connector
suitable for syringes

2475

Articulating
Barrel Syringe

2476

ml 1,8

2477

ml 1,8



2478

2479

2480

2481
Fig. 1
ml 1,8 EU

2482
Water
point

2483
Water
point

2484
Water
point

2485
Fig. 1
ml 1,8 EU



Dental Tweezers



2486
ADSON
Curved 14 cm



2487
ADSON
1X2 / 12 cm



2488
ADSON
12 cm



2489
MICRO ADSON
15 cm



2490
STANDARD
14, 18, 25 cm



2491
CUSHING
18 cm



2492
Curved



2493
SELECT
15, 18, 20 cm



2494



2495
MCINDOE
15 cm



2496
GILLIES
15 cm



2497
WAUGH
15, 20 cm



Serrated

2498
PERRY
13 cm



2499
KOPP
15.5 cm



Dental Tweezers



2500
 COLLEGE
 15 cm



smooth



2501
 COLLEGE
 15 cm



serrated



2502
 COLLEGE
 15 cm



smooth



2503
 COLLEGE
 15 cm



serrated



2504
 COLLEGE
 15 cm



smooth



2505
 COLLEGE
 15 cm



serrated



2506
 COLLEGE
 15 cm



smooth



2507
 COLLEGE
 15 cm



serrated



Dental Tweezers



2508
 MERIAM
 16 cm



smooth



2509
 MERIAM
 16 cm



serrated



2510
 MERIAM
 16 cm



smooth



2511
 MERIAM
 16 cm



serrated



2512
 MERIAM
 16 cm



smooth



2513
 MERIAM
 16 cm



serrated



2514
 MERIAM
 16 cm



smooth



2515
 MERIAM
 16 cm



serrated



Dental Tweezers



2516
COLLEGE
14.5 cm, 5 3/4"

2517
FLAGG
16 cm, 6 1/4"

2518
FLAGG
16 cm, 6 1/4"

2519
LANDGRAF
15 cm, 6"

2520
15.5 cm, 6 1/4"

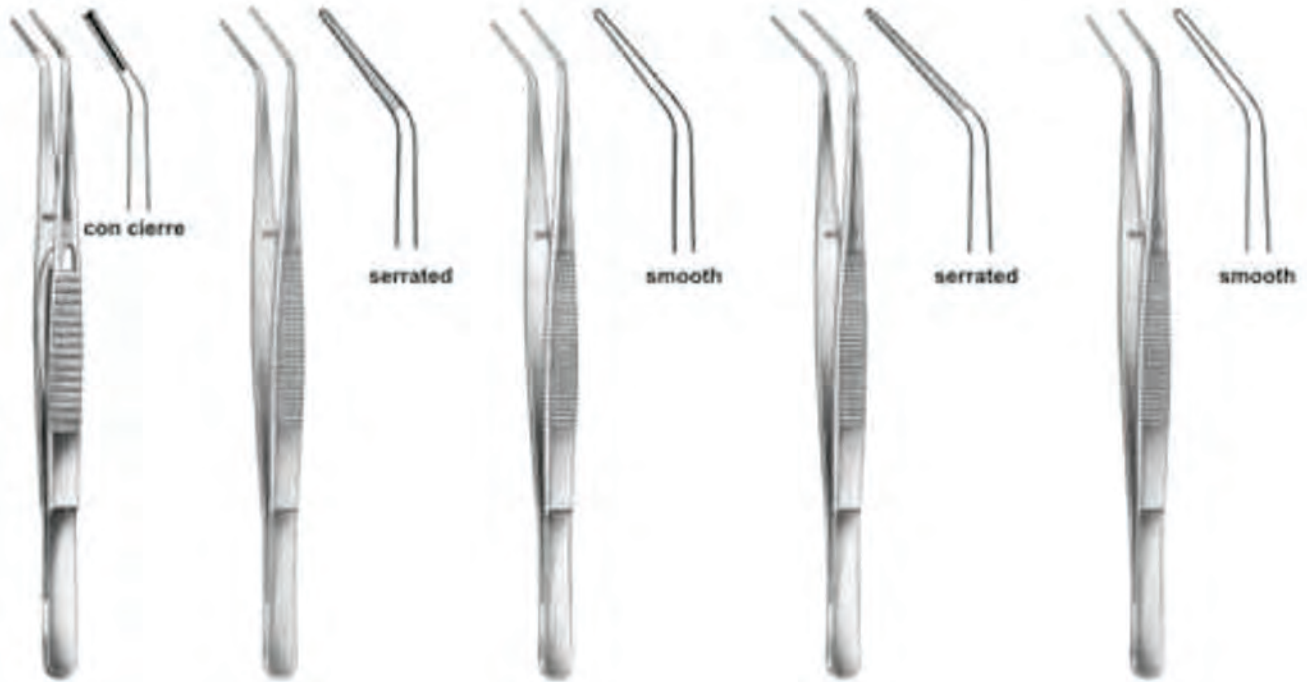

2521
15.5 cm, 6 1/4"

2522
LONDON-COLLEGE
15 cm, 6"

2523
LONDON-COLLEGE
15 cm, 6"

2524
LONDON-COLLEGE
15 cm, 6"

2525
LONDON-COLLEGE
15 cm, 6"



Dental Tweezers



2526
 LONDON-COLLEGE
 15 cm, 6"



2527
 LONDON-COLLEGE
 15 cm, 6"



2528
 MERIAM
 16 cm, 6 1/4"



2529
 ALLEN
 18 cm, 7 1/4"



2530
 ALBRECHT
 16 cm, 6 1/4"



2531
 ALBRECHT
 16 cm, 6 1/4"



2532
 16 cm, 6 1/4"



2533
 16 cm, 6 1/4"



2534
 16 cm, 6 1/4"





Sterilizing & Lab Instruments



2535
DAVIS
6"



2536
Grasping Forceps
6 1/4"



2537
Mesh Bur & Diamond Holder
Large, 2 1/8" Diameter



2538
Soldering Tweezers
6 1/4"



2539
Narrow Fine
4 3/4"



2540
Super Fine
4 3/8"



2541
Fine Curved
4 1/2"



2542
Bonding Bracket
Holder
136 mm



2543
Bonding Bracket
Holder
135 mm



2544
Bonding Bracket
Holder
135 mm



2545
Bonding Bracket
Holder
140 mm

Section - 06

- * Endodontic Forceps
- * Tissue Forceps
- * Retractors
- * Mouth Gags





Endodontic Forceps



2546
Endo Forceps
4 3/4"



2547
PEETS Forceps
4 3/4", Useful For
Removing Broken
Instruments



2548
Without Ratchet
145 mm



2549
With Ratchet
145 mm



2550
CRILE
140 mm



2551
PEAN
Slender type

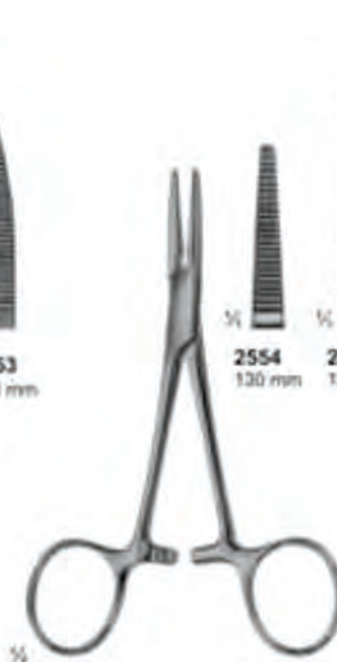

2554
SPENCER-WELLS



2552
130 mm

2553
140 mm

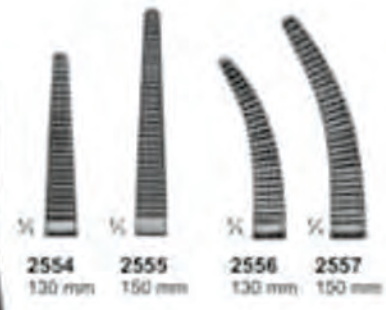

2554
130 mm

2555
150 mm

2556
130 mm

2557
150 mm



Tissue Forceps



2558
BABY-ALLIS
5", Straight
4x5 teeth extra delicate



2559
ALLIS
6", Straight
4x5 teeth extra delicate



2560
ALLIS
6", Straight
4x5 teeth extra delicate



2561
1x2 teeth
6"



2562
SEMKIN
6", Straight,
1x2 teeth



2563
ADSON
4 3/4"
1x2 teeth



2564
BROWN-ADSON
4 3/4"
7x7 teeth



2565
BROWN
6"
8x8 teeth



2566
RUSSIAN
6"
8x8 teeth



2567
Extra-Delicate,
Straight, 4"
1x2 teeth



Hemostatic Forceps, Towel Clamps, Napkin Hold



2568
HALSTED-MOSQUITO
Straight, Curved, 5"



2569
HALSTED-MOSQUITO
Straight, Curved, 5"
1x2 teeth



2570
HALSTED-MOSQUITO
Jaws 45 Angled on Flat, 5"
Extra Delicate



2571
KELLY
5 1/2", Straight



2572
JONES
3 1/2"



2573
BACKHAUS
3 1/2"



2574
BACKHAUS
5 1/4"



2575
LORHA
Non Perforated
3 1/2"



Retractors, Depressors, Mouth Gags



2576
DENHART



2577
DENHARDT
Mouth Gag With
Silicon Inserts,
Interchangeable
Size: 125 mm



140 mm 150 mm



2578
WIEDER
Tongue depressor
2579 140mm
2580 150mm



2583
WEITLANER
Sharp
130 mm



2584
WEITLANER
Sharp
110 mm

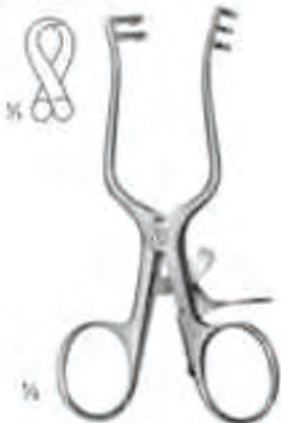

2585
WEITLANER
Semi-Sharp
110 mm



2581
TOBOLD
Tongue depressor
Size: 145 mm



2582
ANDREW
Tongue depressor
Size: 110 mm



2586
MOLT
Pediatric



2587
MOLT
Child



2588
MOLT
Adult



2589
FERGUSSON-ACKLAND
Mouth Gag
Size: 145 mm



2590
ROSER KOENIG
Mouth Gag
Size: 160mm / 185mm



Lip & Cheek Retractors



2591
140 mm

2592
BRUENINGS
190 mm

2593

2594

2595

2596

2597

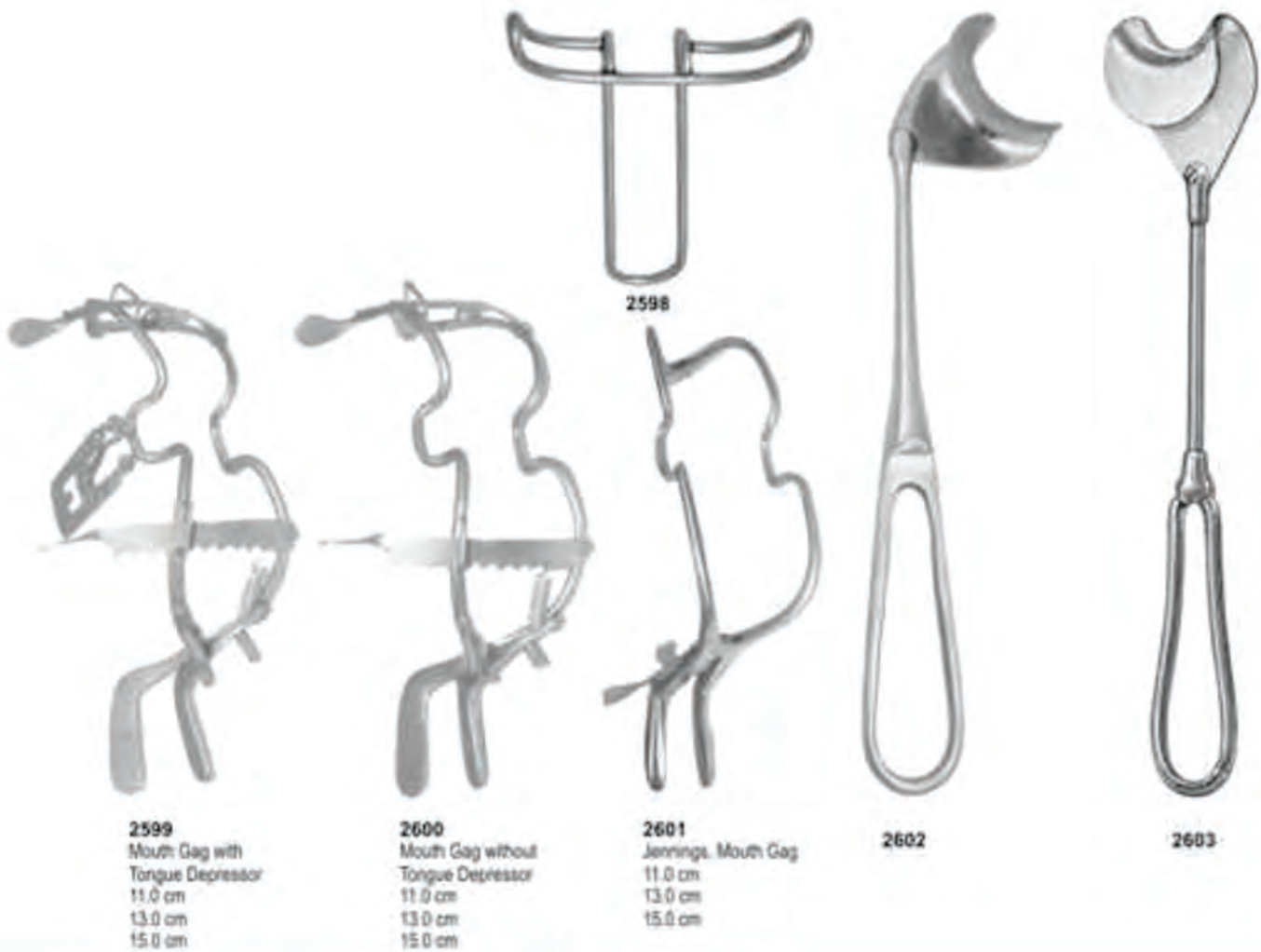

2598

2599
Mouth Gag with
Tongue Depressor
11.0 cm
13.0 cm
15.0 cm

2600
Mouth Gag without
Tongue Depressor
11.0 cm
13.0 cm
15.0 cm

2601
Jennings Mouth Gag
11.0 cm
13.0 cm
15.0 cm

2602

2603



Lip & Cheek Retractor

- 30 x 4 mm A
- 23 x 7 mm B
- 24 x 11 mm C
- 29 x 10 mm D
- 30 x 11 mm E
- 32 x 14 mm F
- 40 x 11 mm G
- 42 x 10 mm H
- 50 x 11 mm I
- 55 x 11 mm J
- 60 x 11 mm K
- 70 x 11 mm L
- 70 x 14 mm M



2604
LANGENBECK
210 mm



2605
KOCHER-LANGENBECK
215 mm



2606
BUCHS
205 mm



38 x 18 mm



2607
KOCHER
230 mm



2608
MIDDELDORPF



2609
15 x 10 mm
220 mm



2610
20 x 22 mm
215 mm



2611
28 x 28 mm
235 mm



2612
KOCHER
230 mm



2613
COLLIN
150 mm



2614
ROUX
Set
165 mm



Sterilizing Forceps



2615
 Sterilizing Forcep Curved
 20 cm A
 25 cm B
 30 cm C



2616
 Sterilizing Forcep Straight
 20 cm A
 25 cm B
 30 cm C



2617
 Sterilizing Forcep
 30 cm



2618
 Becht Tweezer



2619
 Sterilizing Forcep
 23 cm A
 30 cm B



2620
 Sterilizing Forcep
 20 cm





Tissue Retractors & Hooks



2621
 3 sharp prongs



2622
 2 sharp prongs
 6"



2623
 2 sharp prongs
 6"



2624
 FOMON
 145 mm



2625
 ALM
 70 mm



2626
 SENN
 3 sharp prongs
 8 3/8"



2627
 TOENNIS
 Dura Retractor
 150mm



2628
 JOSEPH
 165 mm



2629
 GILLIES
 180 mm

Section - 07

- * Orthodontic Pliers
- * Orthodontic Cutters
- * Rongeurs
- * Needle Holders





Orthodontic Pliers



2630
Light Wire Cutter



2631
Wire Cutter



2632
Posterior Band Remover
Long



2633
Posterior Band Remover
Short



2634
Jarabak Plier



2635
Distal End Cutter
Safety End Cutter



2636
Distal End Cutter



2637
Kim's Plier



2638
Loop Forming Plier



2639
Tweed Arch Bending Plier



2640
Utility Plier



2641
Bonding Bracket Remover



2642
Lingual Arch Plier



2643
Light Wire Plier



2644
Wire Cutter
12.5 cm



Orthodontic Pliers



2645
 Fig. 101
 Wire Bending



2646
 Fig. 118
 PEESO
 Collar



2647
 Fig. 417
 Crown Shell

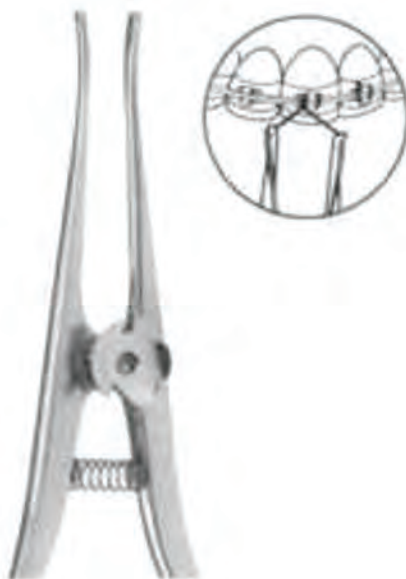

2648
 STEINER
 150 mm
 Ligature Pliers



2649
 Separating Pliers Elastics
 150 mm



2650
 121-Lab & Office



Orthodontic Pliers



2651
How Plier-Titanium Alloy
With special coated beaks



2652
How Plier
Tips are 1/8" (3.2mm)
diameter



2653
How Plier
Tips are 1/8" (3.2mm)
diameter



2654
How Plier-Small
Tips are 3/32" (2.4mm)
diameter



2655
How Plier-Offset
Tips are 1/8" (3.2mm)
diameter



2656
Weingart Utility Plier
-Titanium Alloy
with special coated beaks



2657
Weingart Utility Plier
New type of the Weingart Utility Plier
designed for a more precise operation.



2658
Weingart Utility Plier



2659
Weingart Utility Plier



2660
Weingart Utility Plier



2661
Bird Beak Plier With Cutter
Maximum Bending &
Cutting Capacity:
Wires up to .032"



2662
Bird Beak Plier
Maximum Bending Capacity:
Wires up to .032"



2663
Bird Beak Plier
Maximum Bending
Capacity:
Wires up to .030"



Orthodontic Pliers



2664
TWEED (Fig. 96)
13 cm, 5 1/8"
Tweed Loop Omega Pliers.



2665
TWEED - (Fig. 90)
14 cm, 5 1/2"



2666
O'BRIEN - (Fig. 97)
14 cm, 5 1/2"



2667
TWEED (Fig. 96)
14 cm, 5 1/2"



2668
TWEED (Fig. 95)
13.5 cm, 5 1/4"



2669
SCHWARZ (Fig. 29)
12.5 cm, 5"



2670
NANCE (Fig. 80)
13 cm, 5 1/8"



2671
YOUNG (Fig. 55)
13 cm, 5 1/8"



2672
SCHWARZ (Fig. 30)
13 cm, 5 1/8"



2673
Optical Plier (Fig. 53)
14 cm, 5 1/2"



2674
Schwarz (Fig. 79)
13.5 cm, 5 1/4"



Orthodontic Pliers



2675
NANCE (Fig. 56)
12.5 cm, 5"
Wire bending Pliers



2680
14.0 cm
Goslee Contouring Plier



2676
JOHNSON (Fig. 59)
13.5 cm, 5 1/4"
Contouring Plier.



2678
De La Rosa (Fig. 34)
12.5 cm, 5"
Contouring Plier, Non-Grooved



2677
REYNOLDS (Fig. 61)
13 cm, 5 1/8"
Contouring Plier.



2679
De La Rosa (Fig. 35)
12.5 cm, 5"
Contouring Plier, Grooved



2681
14.0 cm
Goslee Contouring Plier



2682



2683
Fig. 58
12.5 cm, 5"
Lingual Arch Bending Plier



2684
Frevert/Tweed (Fig. 51)
12.5 cm, 5"
Tweed Arch Plier/Standard Jaw



2685



2686
ANGLE (Fig. 52)
13 cm, 5 1/8"
Arch Forming Plier



Orthodontic Pliers



2687
Fig. 60
13 cm, 5 1/8"
Wire & Clasp Bending Pliers



2688
Fig. 60
13 cm, 5 1/8"
Wire & Clasp Bending Pliers



2689
Aderer (Fig. 57)
12 cm, 4 3/4"
Wire & Clasp Bending Pliers



2690
49 e 49 TC
14 cm, 5 1/2"
Band Removing Plier, short pad



2691
50 e 50 TC
14 cm, 5 1/2"
Band Removing Plier, long pad



2692
Fig. 84
14.5 cm, 5 3/4"
Band pinching & ligature
locking plier, serrated



2693
Fig. 72
14 cm, 5 1/2"
Band pinching & ligature
locking plier, serrated



2694
BRACKET (Fig. 82)
13.5 cm, 5 1/4"
Direct Bonding Bracket Remover



2695
BRACKET (Fig. 83)
13.5 cm, 5 1/4"
Direct Bonding
Bracket Remover



Orthodontic Pliers



2696
38c, 38TC
13.5 cm, 5 1/4"
Contouring closing loop pliers,
wire bending, cutter.



2697
40c, 40TC
13.5 cm, 5 1/4"
Contouring pliers light wire pliers
grooved with cutter.



2698
Fig. 81
12.5 cm, 5"
Sling clasp & wire bending plier



2699
Fig. 28
14 cm, 5 1/2"
Sling clasp & wire bending plier.



2700
Fig. 21
13 cm, 5 1/8"
Light wires pliers, grooved



2704
46c - 46 TC
ADAMS - N, 139c
12.5 cm, 5"
Bird beak with cutter.



2701
ADAMS, 23, 23TC
12.5 cm, 5"
Sling clasp & wire bending plier.



2702
ADAMS (Fig. 33)
12.5 cm, 5"
For retaining elements.



2703
ADAMS (Fig. 44)
12.5 cm, 5"
Sling clasp & wire bending plier.



2705
Universal Wire Bending
Pliers (ADAMS) 47 TC, N.64
12.5 cm, 5"
Sling clasp & wire bending plier.



2706
86c, 86 TC
Angle Bird Beak - N, 138
12.5 cm, 5"
Sling clasp & wire bending plier.



Orthodontic Cutters With T.C.



Ø 1.0 mm
(0.40")

2707
Fig. 18 TC
15 cm, 6"



Ø 1.0 mm
(0.40")

2708
Fig. 92 TC
14 cm, 5 1/8"



Ø 0.4 mm
(0.16")

2709
Fig. 91 TC
13 cm, 5 1/8"



Ø 0.4 mm
(0.16")

2710
Fig. 99 TC
13 cm, 5 1/8"



Ø 0.4 mm
(0.16")

2711
Fig. 94 TC
13 cm, 5 1/8"
Angled at 15° with or
without spring on)
the handles.



2712
Fig. 85 TC
13 cm, 5 1/8"



2713
Fig. 87 TC
13 cm, 5 1/8"



2714
Fig. 85 TC
Angled at 15°
13 cm, 5 1/8"



2715
ADAMS 87 TC
Angled at 15°
13 cm, 5 1/8"



Orthodontic Distal & Cutters





Pliers for Orthodontic & Prosthetics



2721
UNIVERSAL
150 mm



2722
WALDSACHS
155 mm



2723
ADERER
125 mm



2724
NANCE
125 mm



2725
REYNOLDS
125 mm



2726
HOW
145 mm



2727
HOW
140 mm



2731
FURRER
150 mm



2728
WALDRON
125 mm



2729
ADAMS
125 mm



2730
ANGLE
125 mm



2732
YOUNG
130 mm



2733
NANCE
130 mm



Pliers for Orthodontic & Prosthetics



2734
LANGEBECK
125 mm



2735
LANGEBECK
140 mm



2736
LANGEBECK
130 mm



2737
PEESO
125 mm



2738
GOSLEE
125 mm



2739
FISCHER
140 mm



2740
FISCHER
140 mm



2741
JOHNSON
130 mm



2742
MSY
130 mm



2743
MC KELLOPS
155 mm



2744
ANDREBEN
130 mm



2745
SCHWARZ
130 mm



Rongeurs



2746
 BLUMENTHAL
 6", 30° Standard



2747
 MINI-BLUMENTHAL
 6", 45°



2748
 MINI-BLUMENTHAL
 6", 90°



2749
 BLUMENTHAL
 7", 30°



2750
 MINI-BLUMENTHAL
 4 1/2", 30°



2751
 MINI-BLUMENTHAL
 4 1/2", 45°



Rongeurs



2752
 CLEVELAND
 No. 5-Side Cutting.
 6 3/4"



2753
 CLEVELAND
 No. 5A-Side Cutting.
 8 1/2"



2754
 CLEVELAND
 No. 5S-Side Cutting.
 8"



2755
 No. 1A-MEAD
 6 1/2"



2756
 MEAD, Square
 No. 2A
 Tips, 6 1/2"



2757



Rongeurs



2757
 FRIEDMAN
 5 1/2"



2758
 MICRO-FRIEDMAN
 5 1/2", 15° Curved Jaws



2759
 MICRO-FRIEDMAN
 Perio Rongeur, 5 1/2"



2760
 CLEVELAND
 No. 4 - 5 1/2"



2761
 CLEVELAND
 No. 4A - 6 1/2"



2762
 GARDNER
 No. 6A, End Cutting
 6 1/2"



Rongeurs



2763
BEYER
 Double Action,
 16,18 cm



2764
 No. 1
 6 1/2"



2765
HARTMAN
 5 3/4"
 Strong Curve



2766
BANE
 Slight Curve
 7"



Needle Holders



2767
COLLIER
 5", Fenestrated Jaws



2768
DERF
 4 3/4"



2769
WEBSTER
 Delicate Smooth Jaws
 5"



2770
NEIVERT
 One Offset Ring
 5"



2771
OLSEN-HEGAR
 5 1/2"



2772
BAUMGARTNER
 5 1/2"



2773
CRILE-WOOD
 6"



2774
GARDNER
 5"



Needle Holders

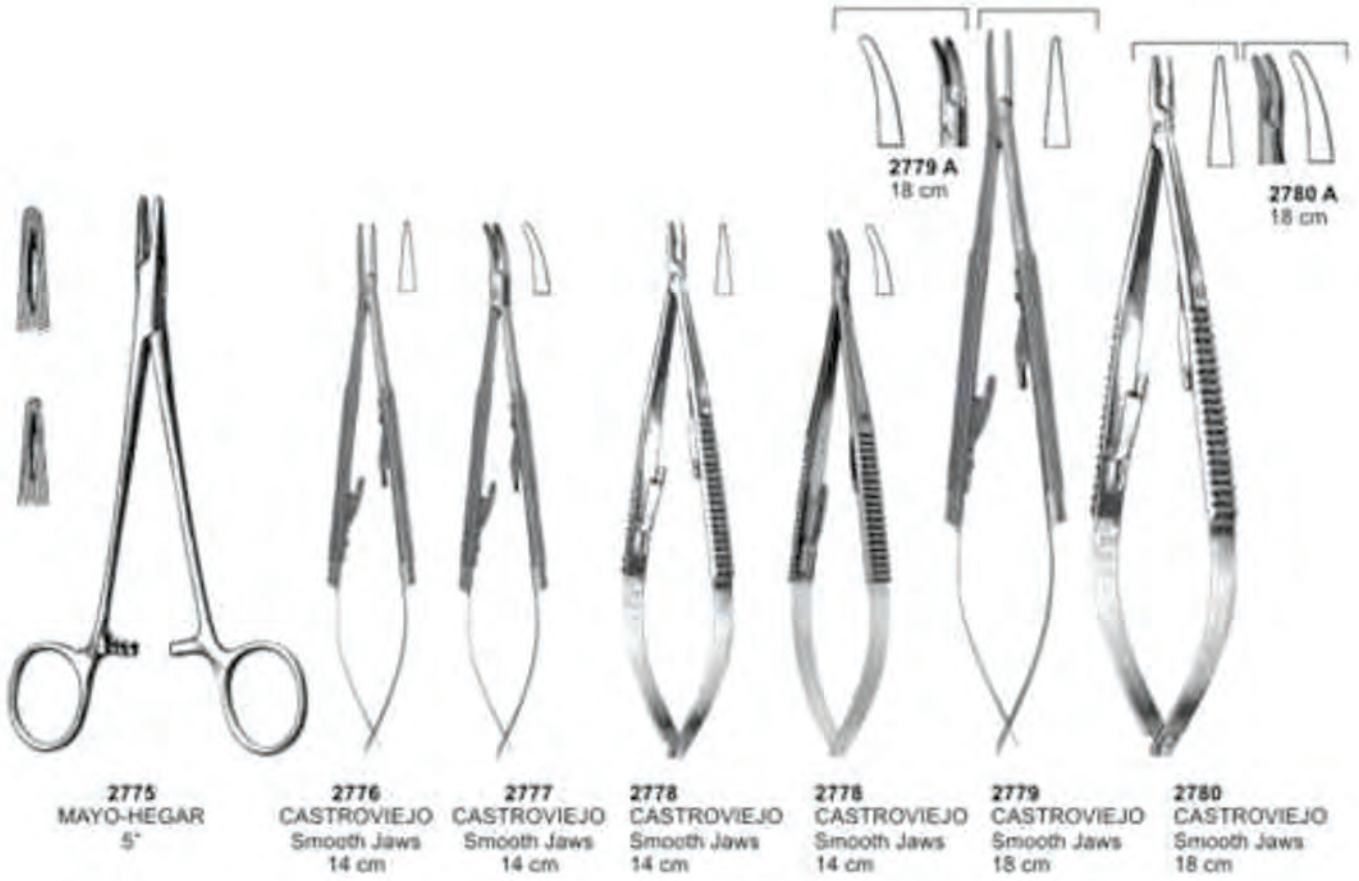

2775
MAYO-HEGAR
5"

2776
CASTROVIEJO
Smooth Jaws
14 cm

2777
CASTROVIEJO
Smooth Jaws
14 cm

2778
CASTROVIEJO
Smooth Jaws
14 cm

2779
CASTROVIEJO
Smooth Jaws
14 cm

2779 A
CASTROVIEJO
Smooth Jaws
18 cm

2780
CASTROVIEJO
Smooth Jaws
18 cm



2781
BOYNTON
5"

2782
CRILE
6"

2783
MATHIEU
5 1/2"

2784
STEVENS
6 1/2"



Micro Surgery Set



2785
Micro Scissor
Straight, 155 mm



2786
Micro Scissor
Straight, 150 mm



2787
Micro Scissor
Curved, 150 mm



2788
Micro Scissor
Curved, 155 mm



2789
CASTROVIEJO
T.C.
Straight, 180 mm



2790
Retractor
Fig-3
165 mm



2791
Micro Adson
120 mm



2792
GERALD
Curved,
180 mm



2793
GERALD
Straight,
175 mm



2794
Micro Adson
160 mm



2795
Micro Surgery Set 10 Pieces.



Scissors



2796
IRIS (Standard)
Straight
11.5 cm, 4 1/2"



2797
IRIS (Standard)
Curved
11.5 cm, 4 1/2"



2798
STEVENS
Dissecting Scissors
Size: 115 mm



2799
Sharp



2800
Sharp



2801
Blunt



2802
Blunt



2803



2804
JOSEPH
Size: 150 mm

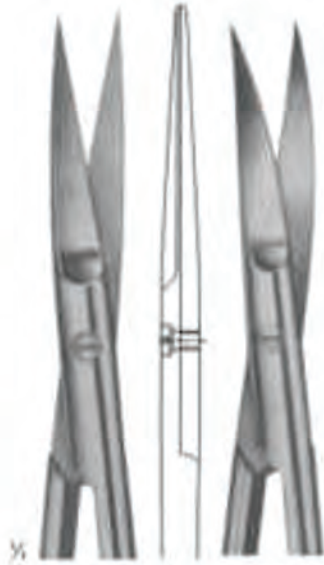

2805



2806

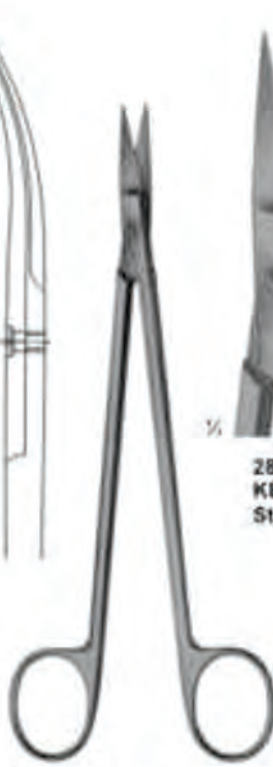

2807
KELLY
Size: 175 mm



2808
KELLY
Straight



2809
KELLY
Curved



2810
QUINBY
Size: 130 mm



Scissors



2811
Standard - Types
Size: 115 mm



2812
DEAVER
With flat lock



2813
Size: 145 mm



2814
Size: 145 mm



2815
Size: 145 mm



2816
LITTLER
Dissecting Scissors
Size: 115 mm



2817
COTTLE
Bulldog Scissors
Size: 115 mm

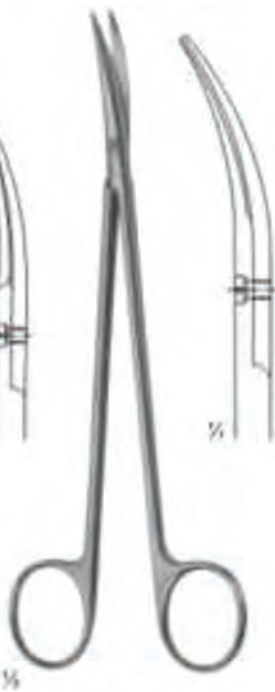

2818
DE BAKEY
Ateriotomy scissors
Size: 175 mm

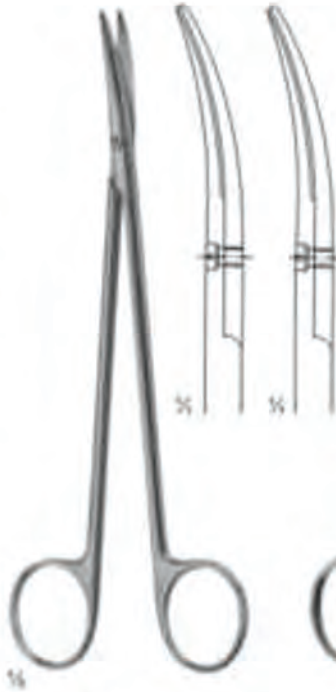

2819
TOENNIS - ADSON
Dissecting scissors
Size: 175 mm



2820
KNOWLES
Size: 145 mm



2821
LISTER



Scissors

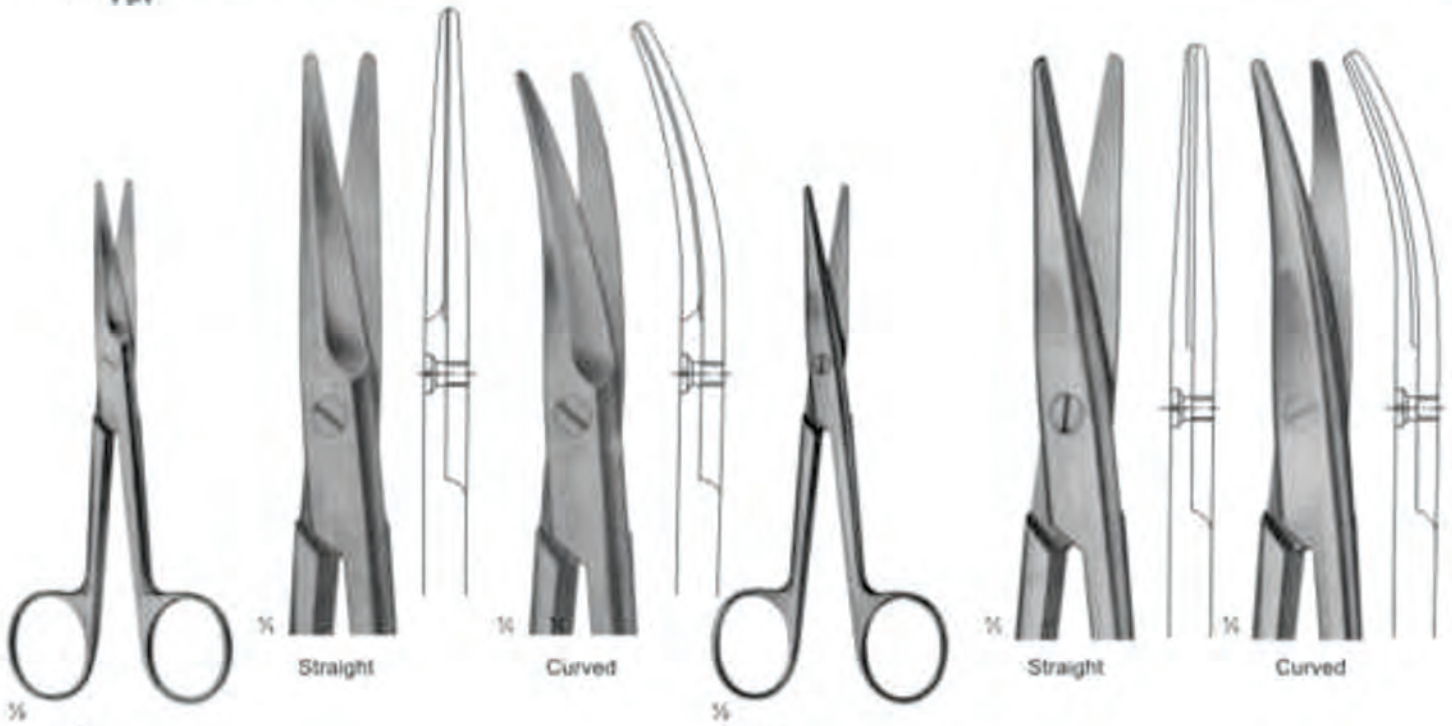

2822
MAYO (straight)
Size: 140 mm

2823
MAYO-STILLE (straight)
Size: 140 mm



2824
STILLE
Size: 140 mm

2825
METZENBAUM
Size: 145 mm

2826
NELSON-METZENBAUM
Size: 230 mm



Scissors



2827
DE BAKEY
Size: 155 mm



2828
LOCKLIN
Curved Sideways,
1 Toothed Blade
Size: 155 mm



2829
LaGrange
Double-Curved
11.5 cm



2830
Goldman-Fox
Double-Curved
13cm



2831
SPENCER
Size: 90 mm



2832
LITTAUER
Size: 135 mm



2833
BEEBE
Size: 110 mm



2834

2835

2836

2837



2838
Dean
17cm



2839
1 Blade Serrated
Size: 120 mm



2840
CASTROVIEJO
Size: 90 mm



Impression Trays

Made of 18/8 Stainless Steel, Solid, Set of 10

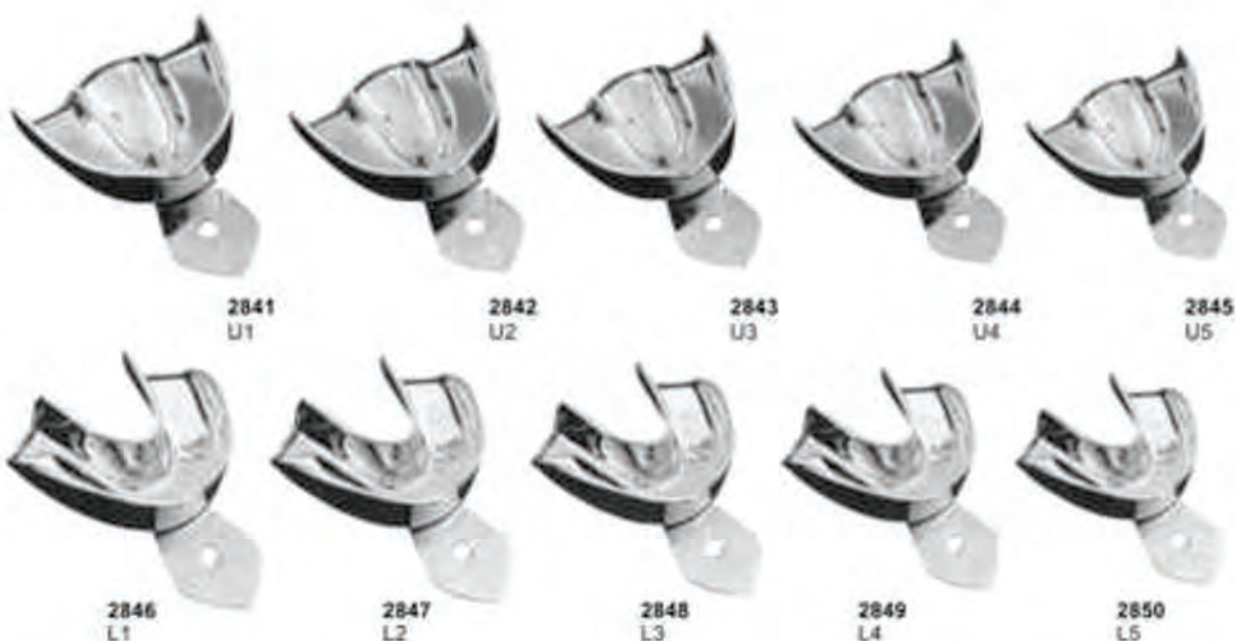

All The Above Impression Trays are Available in These 5 Sizes



UPPER	U1	U2	U3	U4	U5
	A	62	60	53	54
B	83	75	73	69	68

All Dimension are in mm

LOWER	L1	L2	L3	L4	L5
	A	63	61	57	60
B	82	81	78	74	71

All Dimension are in mm

Perforated, Set of 10

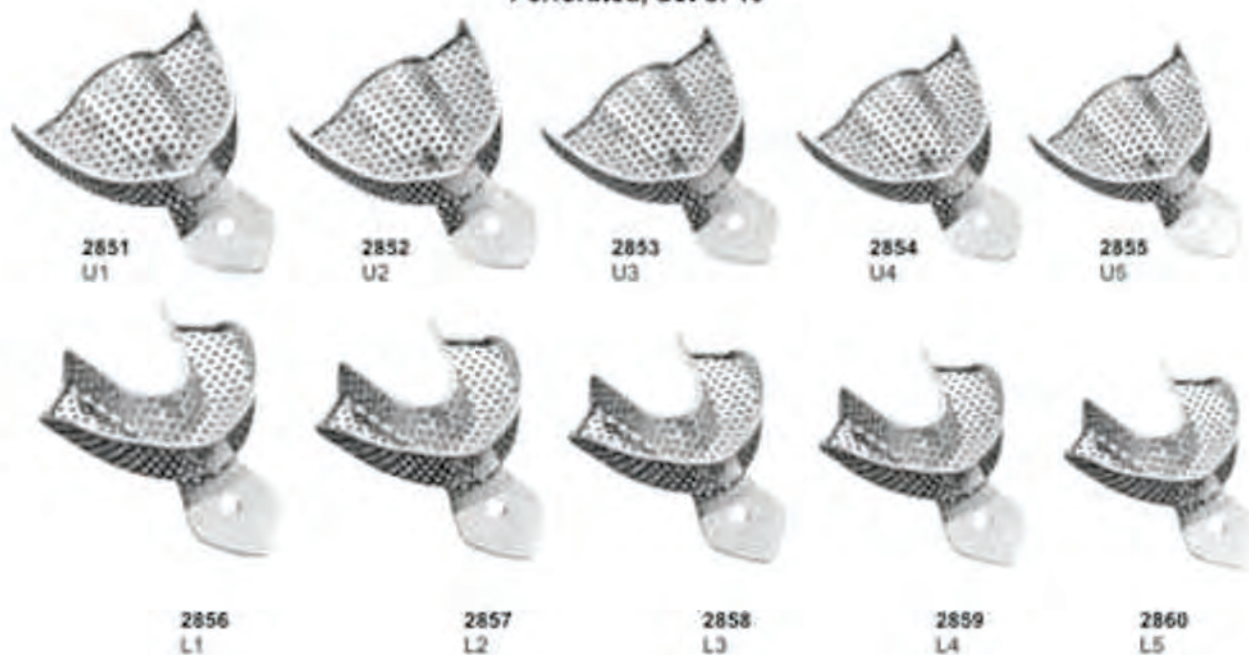



Impression Trays

Made of 18/8 Stainless Steel, Solid Full Denture Set of 8



All The Above Impression Trays are Available in These 4 Sizes

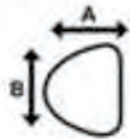

UPPER		XL	L	M	S
	A	70	67	64	60
B	79	76	70	73	

All Dimension are in mm

LOWER		XL	L	M	S
	A	64	64	60	57
B	86	70	73	70	

All Dimension are in mm

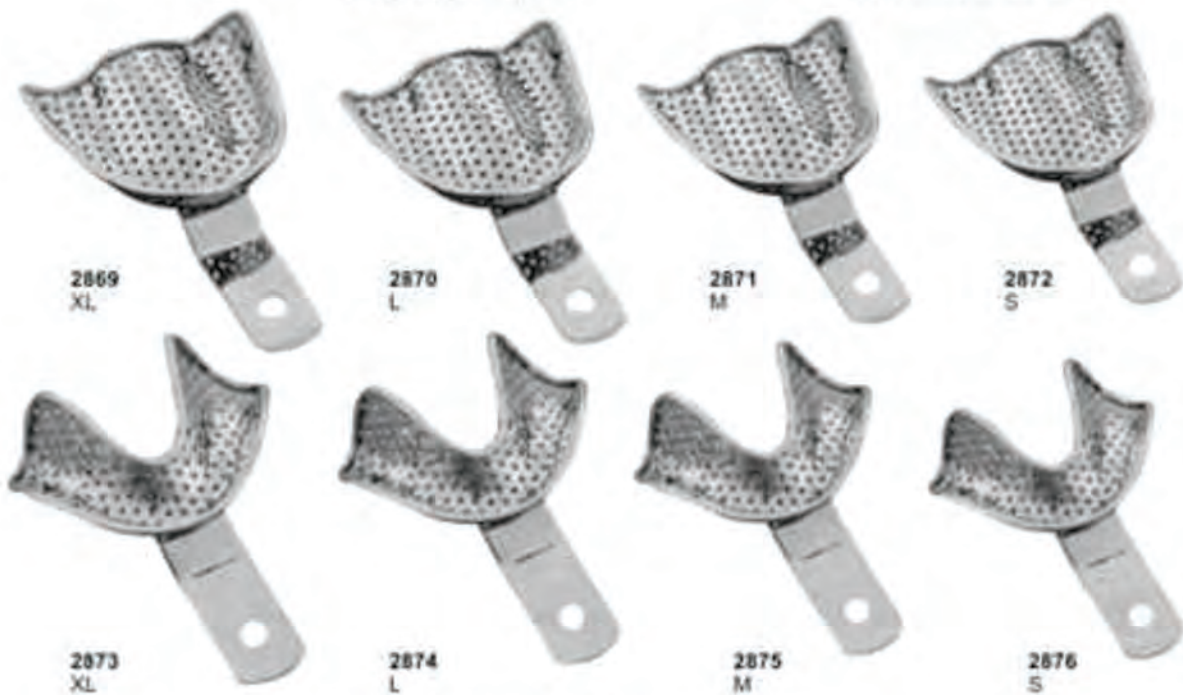

Perforated Full Denture Set of 8



Impression Trays

Made of 18/8 Stainless Steel, Solid Set of 6



2877
U1

2878
U2

2879
U3

2880
L1

2881
L2

2882
L3

All The Above Impression Trays are Available in These 4 Sizes

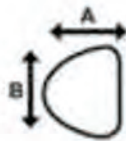

UPPER		U1	U2	U3
	A	67	64	57
B	81	71	70	

All Dimension are in mm

LOWER		L1	L2	L3
	A	60	57	54
B	81	79	76	

All Dimension are in mm



2883
U1

2884
U2

2885
U3

2886
L1

2887
L2

2888
L3

Perforated Set of 6



Impression Trays

Made of 18/8 Stainless Steel, English Pattern Set of 8



2889
Lower



2890
Upper



2891
Lower



2892
Upper



2893
Lower



2894
Upper

All The Above Impression Trays are Available in These 4 Sizes



UPPER	Size	A	B	C
	0	67	50	12
	1	72	51	13
	2	78	55	15
	3	80	58	15

All Dimension are in mm

LOWER	Size	A	B	C
	0	70	50	14
	1	77	51	15
	2	79	55	15
	3	80	60	17

All Dimension are in mm

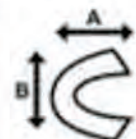



Impression Trays

Made of 18/8 Stainless Steel, Solid Full Denture Set of 8



All The Above Impression Trays are Available in These 4 Sizes



UPPER		XL	L	M	S
	A	70	67	64	60
B	79	76	70	73	

All Dimension are in mm

LOWER		XL	L	M	S
	A	64	64	60	57
B	86	70	73	70	

All Dimension are in mm

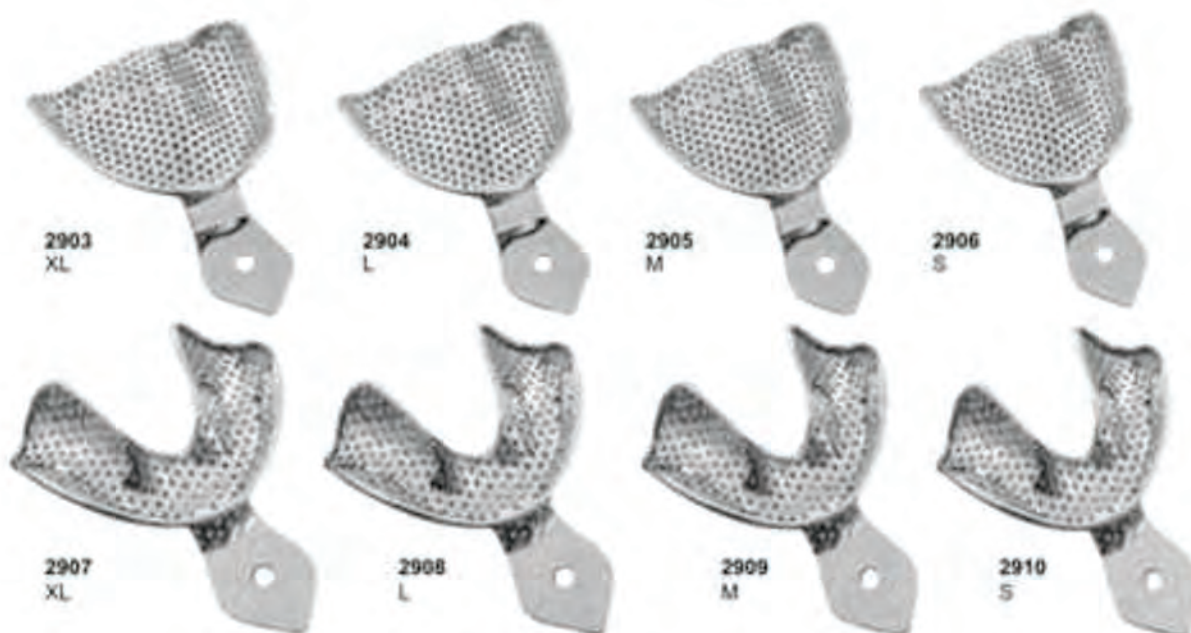

Made of 18/8 Stainless Steel, Perforated Full Denture Set of 8



Impression Trays

Made of 18/8 Stainless Steel, Solid Full Denture Set of 8

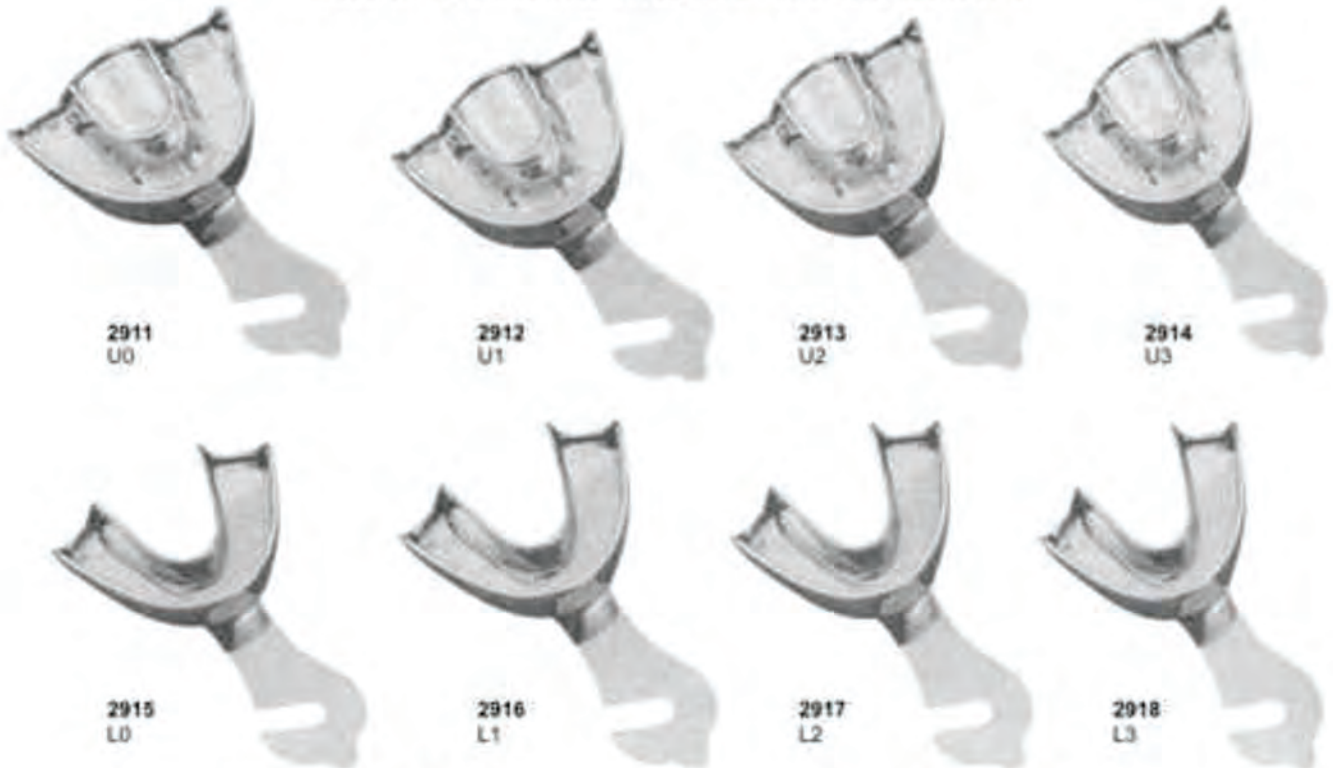

2911
U0

2912
U1

2913
U2

2914
U3

2915
L0

2916
L1

2917
L2

2918
L3

Upper Sizes: 0,1,2,3

Depth of Tray: 15,9 mm, Height of Plate: 12,5 mm

Lower Sizes: 0,1,2,3

Depth of Tray: 12,9 mm

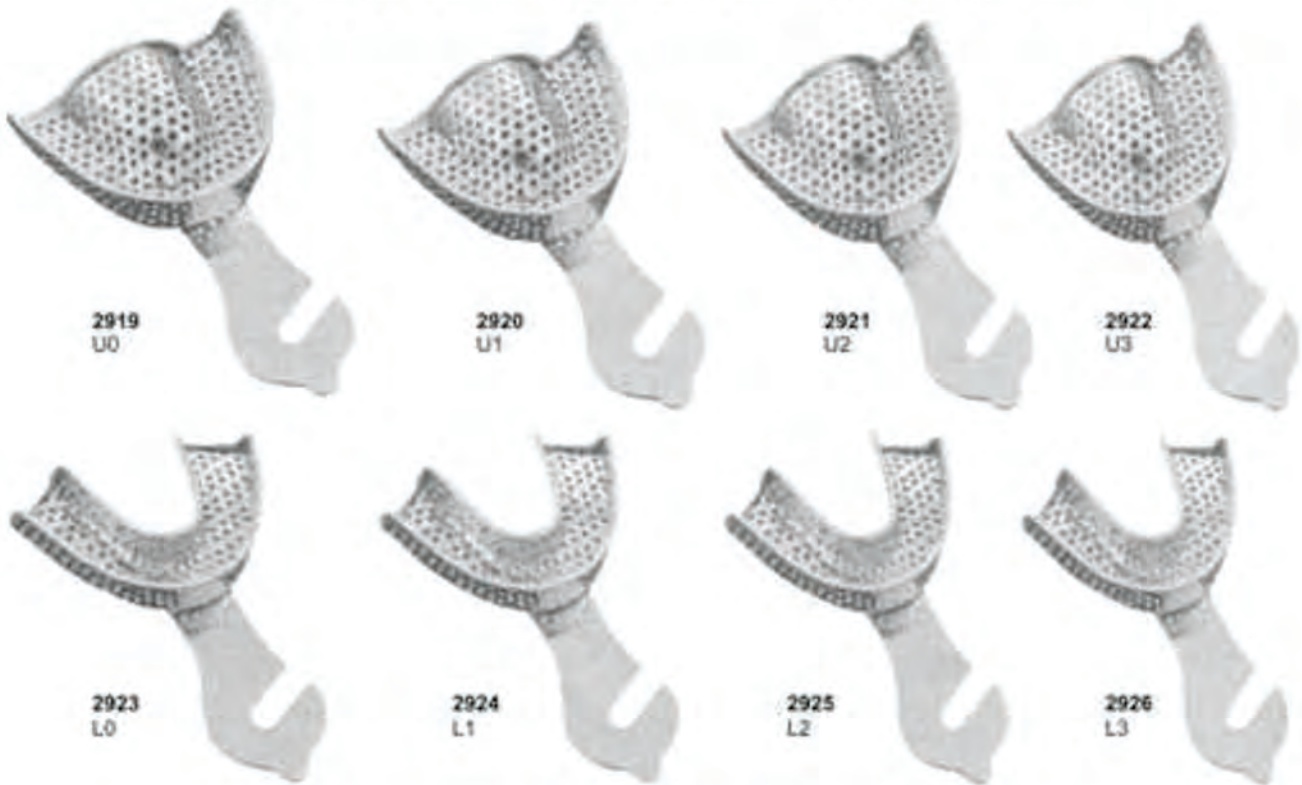

2919
U0

2920
U1

2921
U2

2922
U3

2923
L0

2924
L1

2925
L2

2926
L3

Made of 18/8 Stainless Steel, Perforated Full Denture Set of 8



Impression Trays

Impression Trays For Crown & Bridge Work



2927
UTP



2928
L1P

SOLID



2929
U1P



2930
L1P

PERFORATED



2932
Adjustable
Perforated



2933
Adjustable
Solid

PERFORATED



2931-A
For upper right jaw
For lower left jaw

2931-B
For upper left jaw
For lower right jaw

Available in 4 sizes

- 1.....44 mm
- 2.....55 mm
- 3.....60 mm
- 4.....65 mm

SOLID



2931-C
For upper right jaw
For lower left jaw

2931-D
For upper left jaw
For lower right jaw

Available in 4 sizes

- 1.....44 mm
- 2.....55 mm
- 3.....60 mm
- 4.....65 mm



Articulators



2934



2935



2936



2937



2939



2938



Articulators



2940



2941



2942



2943



2944



2945



2946



2947



Hollow Wares



2948
 Instruments Tray of 20 Pcs



2951
 Instruments Riddle



2949
 Instruments Tray of 7 Pcs



2949-A
 Instruments Tray of 10 Pcs



2950
 Instruments Tray of 5 Pcs



2952
 Instruments Tray of 5 Pcs



2953
 Instruments Tray



2954
 Instruments Tray
 Perforated



2955
 Instruments Tray
 Perforated Base



2956
 Instruments Tray
 Solid Base



Hollowares



2957
Pulpectomy Tray

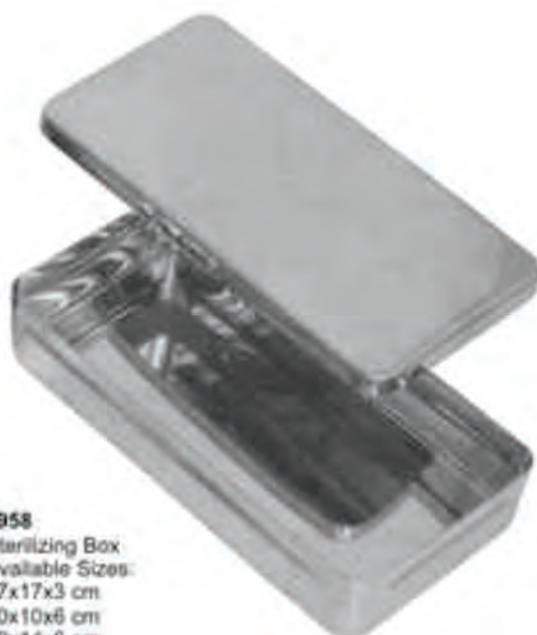

2958
Sterilizing Box
Available Sizes:
17x17x3 cm
20x10x6 cm
30x14x6 cm



2959
Endo Tray Box



2960
Finger Cup



2961
Bur Box

2962
Sterilizing Drum
150x150mm
175x175mm
190x190mm
200x140mm
200x200mm
240x120mm
225x225mm
240x240mm
290x160mm



2963
Sterilizing Drum
280x240mm
230x150mm
300x250mm
340x160mm
350x250mm
390x200mm
380x300mm
100x100mm
150x120mm



Sterilizing Boxes & Instruments Trays



2964
Instruments Box



2965
Instruments Box



2966
Instruments Box



2967
Instruments Sterilizer
150x75 mm



2968
Endodontic Box



2969
Sterilizing Box
320x120 mm



2970
Instruments Tray



2971
Instruments Tray



2972
Instruments Tray
(Perforated)



2973
Instruments Tray
Shallow(Mayo)



2974
Scaler Tray
20.0 x 10.0 x 1.5 cm



2975
Scalers Tray



2976
Scalers Tray



Hollow Wares



2977

2978

2979

2980

Forcep and Thermometer Jars

2961

Cotton Holding Jar
 60x50 mm

2982

Spitten Mug

2983

Spirit Burner With Wick
 Stainless Steel 18/10
 Capacity: 150 ml, 60 ml

2984

Spirit Burners With Wick
 Stainless Steel 18/10
 Capacity: 70ml

2985

Dressing Jar

2986

Dressing Jar

2987

Irrigator(Douch Can)

2988

Measuring Jug



Hollow Wares



2989
Sponge Bowl



2990
Wash Basin
300mm-350mm-400mm



2994
Kick Bucket With Trolley



2991
Sponge Bowl



2992
Gallipot



2993
Medicine Cup



2995
Kidney Tray Shallow
150mm-200mm-240mm-300mm



2996
Kidney Tray Without Lid
150mm-200mm-250mm-300mm



2997
Kidney Tray With Lid
150mm-200mm-250mm-300mm

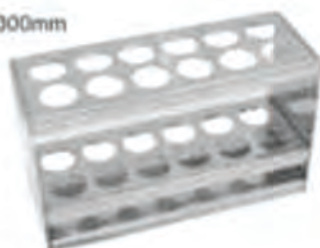

2998
Tube Rack, Stainless Steel 18/10



2999
Needle Case Rectangle
Needle Case Round With Cover
90x15



3000
Dustbin Without Stand
6-10-12 Ltr



3001
Tube Rack, Round Model
Stainless Steel 18/10



3002
Dustbin Without Stand & Cap
6-10-12 Ltr



3003
Lotion Bowl With Lip
40-60-80-100-120-150-180-200mm



Scissors With Tungsten Carbide Inserts



3004
Standard



14,5cm
16,5cm
18,5cm



3005
Standard



14,5cm
16,5cm
18,5cm



3006
Standard



14,5cm
16,5cm
18,5cm



3007
Standard



14,5cm
16,5cm
18,5cm



3008
Standard



14,5cm
16,5cm
18,5cm



3009
Standard



14,5cm
16,5cm
18,5cm



Scissors With Tungsten Carbide Inserts



3010
MAYO-LEXER
Straight
16 cm



3011
MAYO-LEXER
Curved
16 cm



3012
LEXER
Straight
16, 21 cm



3013
LEXER
Curved
16, 21 cm

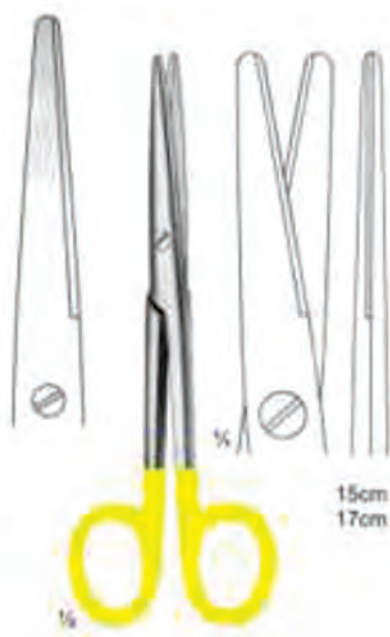

3014
MAYO-STILLE
Straight
15, 17 cm



3015
MAYO-STILLE
Curved
15, 17 cm



Scissors With Tungsten Carbide Inserts



18cm 11.5cm
20cm 14.5cm
28cm 23.5cm
30cm 25.5cm

3016
METZENBAUM
Straight



11.5cm 14.5cm
23cm 25cm

3017
METZENBAUM
Curved



18cm 20cm
28cm 30cm

3018
METZENBAUM
Curved



14cm 18cm 20cm
23cm 25cm 28cm

3019
METZENBAUM FINO
Straight



14cm 18cm 20cm
23cm 25cm 28cm

3020
METZENBAUM FINO
Curved



14cm 18cm
20cm 23cm

3021
METZENBAUM FINO
Sharp



3022
BRUNS
235 mm



Scissors With Tungsten Carbide Inserts



14cm 18cm
 20cm 23cm

3023
 METZENBAUM FINO



18cm
 20cm
 23cm

3024
 METZENBAUM FINO



18cm
 20cm
 23cm

3025
 METZENBAUM FINO



20cm
 23cm

3026
 METZENBAUM FINO



14,5cm
 17cm
 23cm

3027
 MAYO
 Straight



14,5cm
 17cm
 23cm

3028
 MAYO
 Curved



Scissors With Tungsten Carbide Inserts



3029
SIMS



23cm

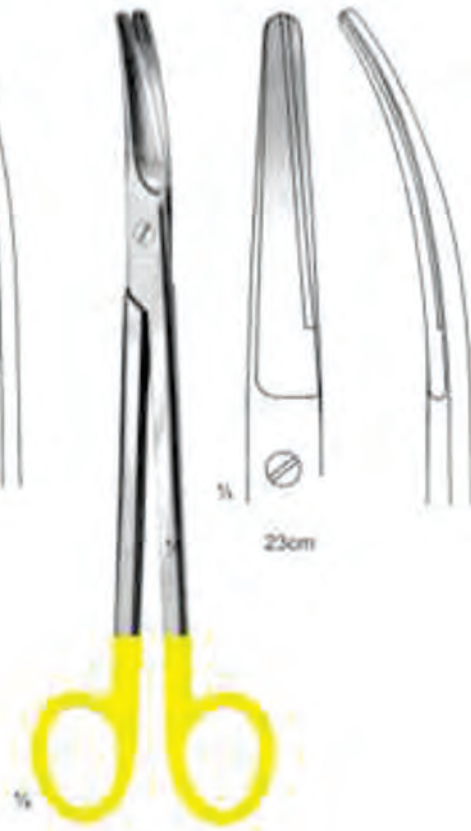

3030
PARAMETRIUM



23cm



3031
MAYO-HARRINGTON



28cm



3032
KELLY
Straight 16 cm



3033
KELLY
Curved 16 cm



3034
DEAN
17 cm



3035
LAGRANGE
Double-Curved
11.5 cm



Scissors With Tungsten Carbide Inserts



3036
DE-BAKEY



3037
DE-BAKEY



3038
GOLDMAN FOX
13 cm



3039
GOLDMAN FOX
Double-Curved
13 cm



3040
GOLDMAN FOX
13 cm



3041
Fine Scissors
Straight
11,5 cm



3042
Fine Scissors
Curved
11,5 cm



3043
Fine Scissors
Angled
11,5 cm



3044
RAGNELL
Curved
12 cm



Scissors & Dissecting Forceps With Tungsten Carbide Ins





Dissecting Forceps & Needle Holders T.C Instrume

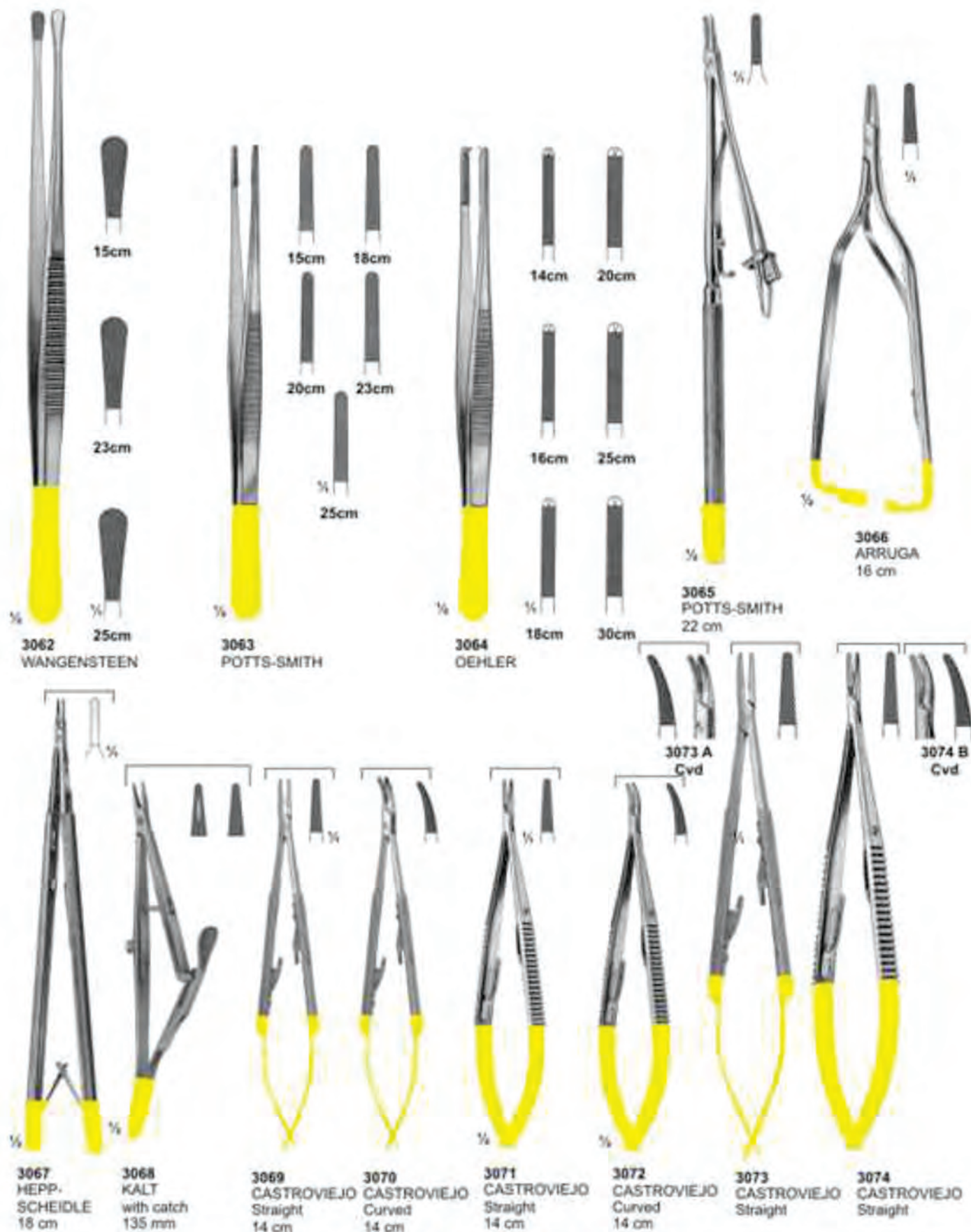



Needle Holders With T.C. Inserts



3075
ARRUGA
Curved
16 cm

3076
CASTROVIEJO
13 cm

3077
HEGAR
20,24 cm

3078
SMOOTH TIP
15 cm

3079
HALSEY
13,15 cm

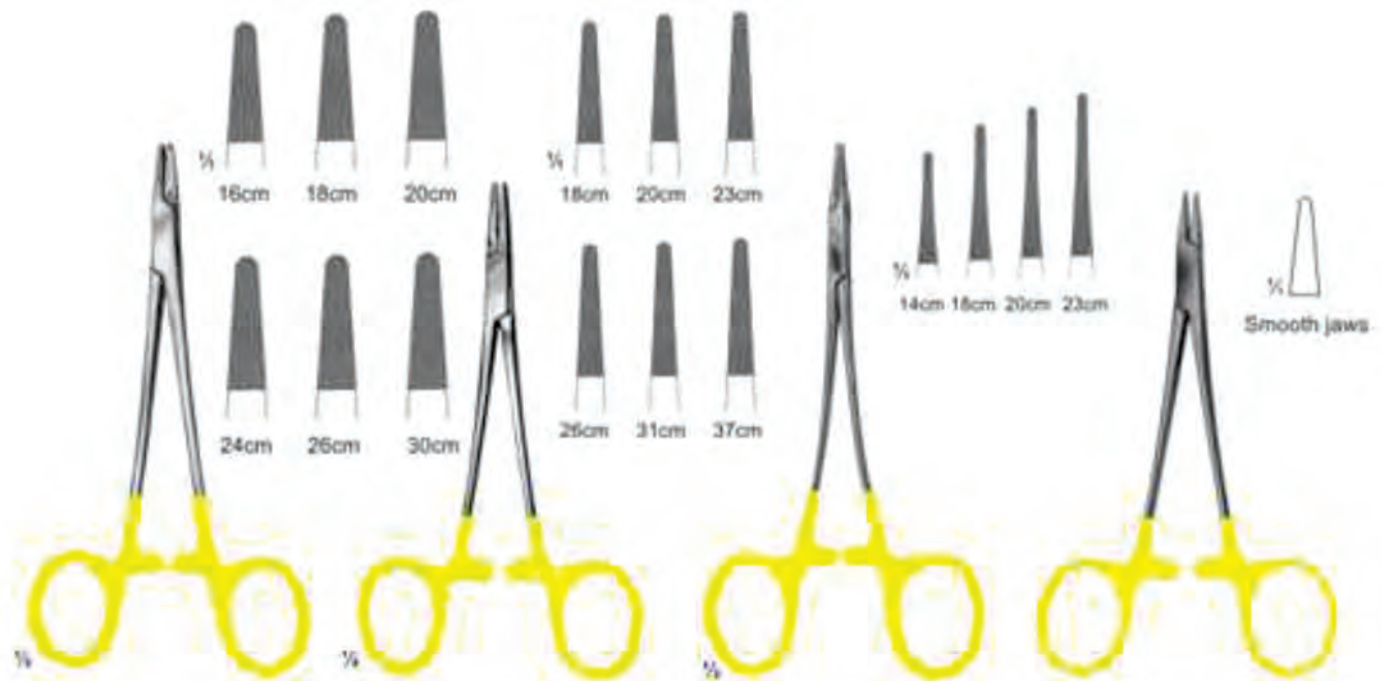

3080
MAYO-HEGAR

3081
DE BAKEY

3082
HEGAR-VASCULAR

3083
WEBSTER
125 mm



Needle Holders With Tungsten Carbide Inserts

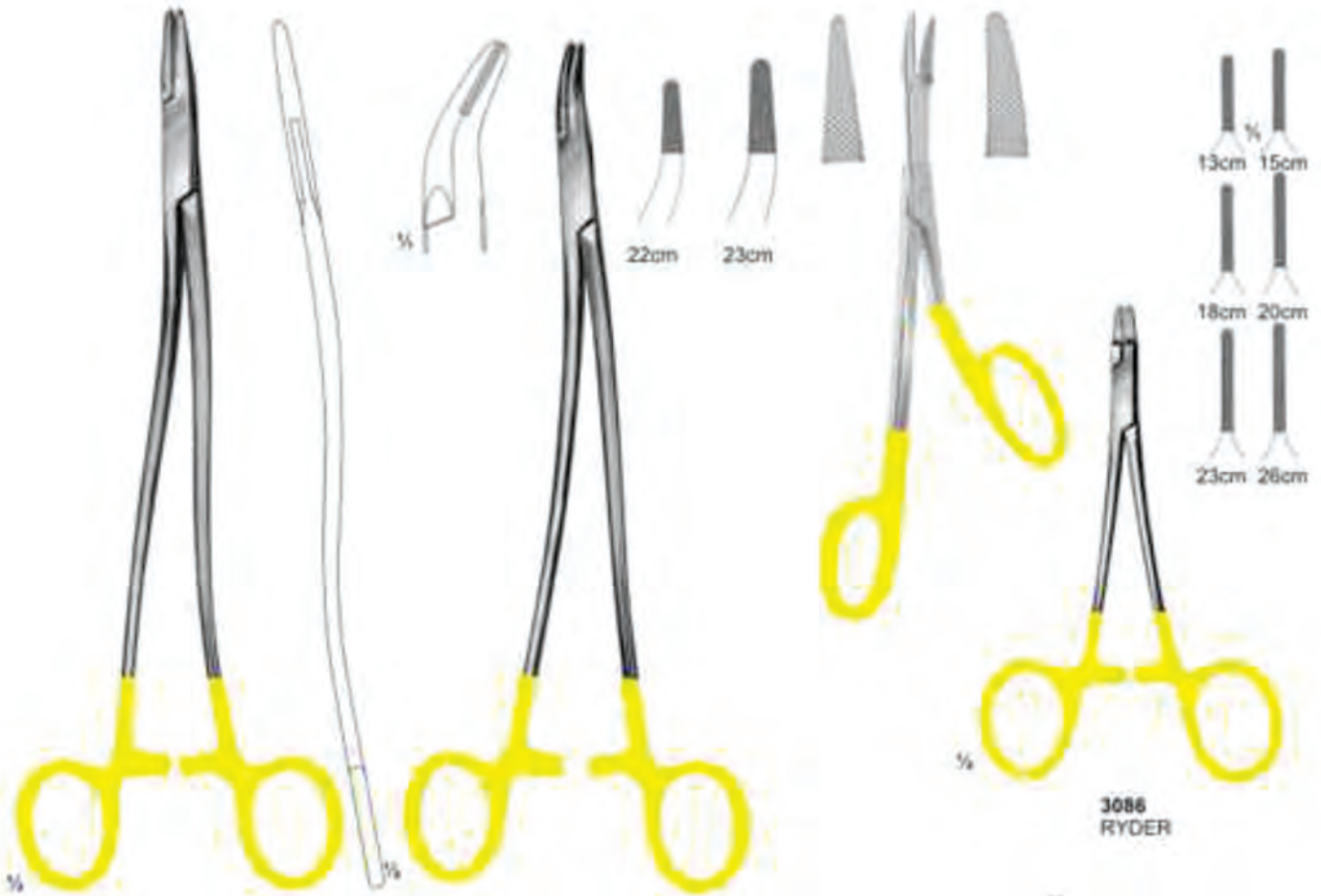

3084
BOZEMANN-WERTHEIM
20, 24, 26 cm

3085
STRATTE

3086
RYDER



3087
RYDER-VASCULAR



3088
MARTIN



3089
SAROT



Needle Holders With Tungsten Carbide Inserts

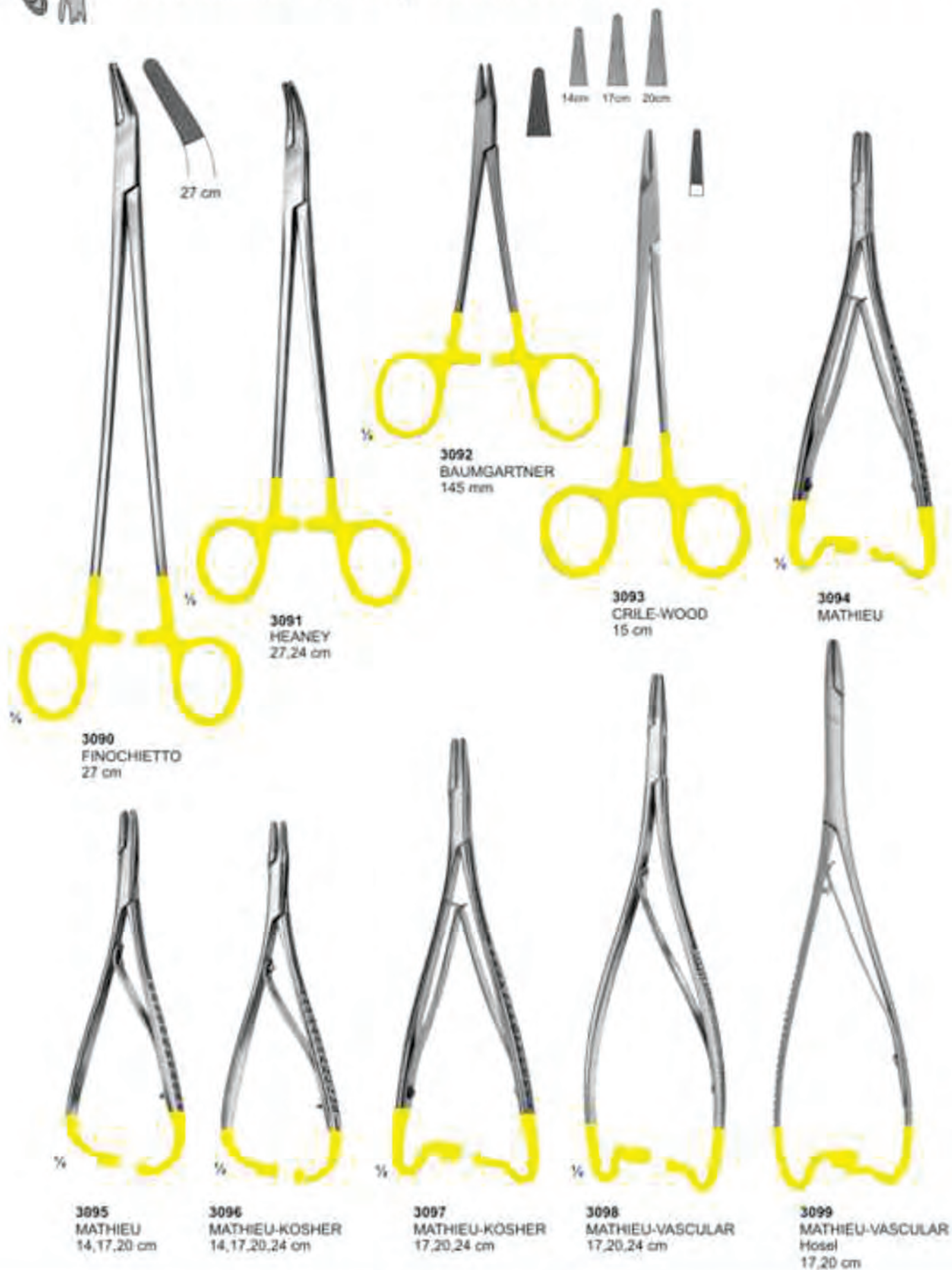



Needle Holders With T.C. Inserts



3100
 MATHIEU-RYDER
 17,20,24 cm



3101
 Hosel
 Curved
 20 cm



3102
 LICHTENBERG
 20 cm



3103
 LANGHALS
 20,25 cm



3104
 LICHTENBERG
 20,25 cm



3105
 LUEHTY-BECK
 20,25 cm



3106
 LUEHTY-BECK
 20,25 cm



3107
 LANGENBECK
 18,20,23 cm



3108
 LANGENBECK
 18,20,23 cm



Wire Cutting Plier With T.C. Inserts



3109
TOENNIS
 Elastic pattern for
 dura-or intestinal suture.
 180 mm



3110
 Cutting Plier
 12 cm



3111
MULLAR CLAUS
 22 cm



3112
 Plier
 17.5 cm



Alphabetical Index

A

Adams, Pliers	174
Aderer, Pliers	174
Adson, Forceps	158,207
Adson, Tweezers	151
Ainsworth, Rubber Dam Punch	147
Albee	143
Albrecht, Tweezers	155
Allen, Tweezers	155
Allis, Tissue Forceps	158
Amalgam Applicators	97
Amalgam Condensers	97
Amalgam Pluggers	97
Amalgam Carriers	145
Amalgam Guns	145
Andresen, Pliers	175
Andrews, Tongue Depressor	160
Angle, Pliers	169,174
Apical, Elevator	57,63
Arruga, T.C. Needle Holder	208,209
Articulators	194-195
Aspirating Syringes	149
Allen 9A, Elevator	50

B

Baby-Allis, Tissue Forceps	158
Band Removing Pliers	170
Bane, Rongeurs	179
Barnhart, Curettes	110,116
Barry, Elevator	66,69
Baum Gartner, Needle Holder	180,211
Bee Be, Scissors	186
Bein, Elevator	54,61
Beyer, Rongeurs	179
Bird Beak Pliers	167
Blumenthan, Rongeurs	176
Boley Gauge	143
Bone Curettes	129
Boynton, Needle Holder	181
Bozemann-Wertheim, T.C. Needle Holder	210
Bracket, Pliers	170
Brewer, Rubber Dam Instruments	147
Brown, Tissue Forceps	158
Brown-Adson, Tissue Forceps	158
Bruns, T.C. Scissors	203
Buchs, Retractor	162
Burnishers	99-100
Ball Chain	146
Boley Gauge,	143

Bone Gauge,	144
Bone Mill Forcep,	139
Bone Pluggers,	140
Bracket, Gauge	144
Buser, Elevator	52

C

Carvers	102,103
Castroviejo, Needle Holder	181,208,209
Castroviejo, scissors	186
Castroviejo, Gauge	144
Castroviejo, Sclerer Marker	144
Cement Instruments	118,119,121
Cement Spatulas	120,122
Chisels	103
Chompret, Elevator	63
Cleveland, Rongeurs	177,178
College, Tweezers	152,154
Collier, Needle Holder	180
Collin, Retractor	162
Columbia, Curettes	110,111,116
Composite Placement	104,105
Con Scodellino, Wax Knives	126
Cord Packers	95
Cottle, Scissors	184
Coupland, Elevator	58
Crane-Kaplan	128
Crile, Forceps	157
Crile, Needle Holder	181
Crile-Wood, Needle Holder	180
Crown Instruments	135,136
Crown Removers	134,135
Crown Shell, Pliers	166
Cryer, Elevator	55,58,69
Cushing, T.C. Forceps	207
Cushing, Tweezers	151
Cushing-Taylor, T.C. Forceps	207

D

De Bakey, T.C. Forceps	207
De Bakey, Scissors	184,186,206
De Bakey, T.C. Needle Holder	209
De La Rosa, Pliers	169
Deaver, Scissors	184
Denhart, Mouth Gag	160
Derf, Needle Holder	180
Disposable Products	117
Dr.Sader, Elevator	69
Dressing Forceps	207
Dean Scissors	186,205



Alphabetical Index

Langenbeck, T.C. Needle Holder	212	Mini-Blumenthan, Rongeurs	176
Langer, Curettes	110,116	Molt, Elevator	50
Langhals, T.C. Needle Holder	212	Molt, Mouth Gag	160
Lecluse, Elevator	65	Molt 9, Elevator	50
Lessmann, Wax Knives	126	Morrison, Elevator	56
Lexer, T.C. Scissors	202	Mouth Mirrors with Handles	73
Lichtenberg, T.C. Needle Holder	212	MSY, Pliers	175
Ligature, T.C. Scissors	207	Mullar Claus, Wire Cutting Pliers T.C.	213
Lip & Cheek Retractors	161,162		
Lister, Scissors	184	N	
Littauer, Scissors	186	Nance, Pliers	168,169,174
Littler, Scissors	184	Napkin Holders	146
Locklin, Scissors	186	Neivert, Needle Holder	180
London Hospital, Elevator	62	Nelson-Metzenbaum, Scissors	185
London-College, Tweezers	154,155	Non Chill	146
Lucae, T.C. Forceps			
Luehty-Beck, T.C. Needle Holder	212	O	
Lwanson, Crown Gauge	143	O'Brien, Pliers	168
Lagrange, Scissors	186,205	Obturation Instruments	88
Littaure, Scissors	186	Ochsenbein	128
Lwanson, Crown Gauge	143	Ordan, knife	114
		Oehler, T.C. Forceps	208
M		Olsen-Hegar, Needle Holder	180
Martin, T.C. Needle Holder	210	Optical Pliers	168
Mathieu, Needle Holder	181,211	Orthodontic Cutters, T.C.	172
Mathieu-Kosher, T.C. Needle Holder	211	Orthodontic Distal & Cutters	173
Mathieu-Ryder, T.C. Needle Holder	212	Orthodontic Pliers, T.C.	171
Mathieu-Vascular, T.C. Needle Holder	211	Ott, Elevator	62
Mayo Harrington, T.C. Scissors	205		
Mayo, Scissors	185,204	P	
Mayo-Hegar, Needle Holder	181	Parametrium, T.C. Scissors	205
Mayo-Hegar, T.C. Needle Holder	209	Partsch, Bone Chisels	133
Mayo-Lexer, T.C. Scissors	202	Partsch, Bone Mallet	133
Mayo-Stille, T.C. Scissors	202	Pean, Forceps	157
Mayo-Stille Scissors	185	Peeso, Pliers	166,175
Mc Kellops, Pliers	175	Peets, Forceps	157
Mocalls, Curettes	110,111,116	Perry, Tweezers	151
McIndoe, Tweezers	151	P.K. Thomas,	96
Mead, Bone Mallets	133	Pich,	98
Mead, Elevator	64	Pluggers,	98
Mead, Rongeurs	179	Prichard, Elevator	50
Meriam, T.C. Forceps	207	Plastic Handle Elevators	70
Meriam, Tweezers	153,155	Polokoff, Bone File	131
Metzenbaum Fino, T.C. Scissors	203,204	Pott, Elevator	51
Metzenbaum, Scissors	185,203	Potts-Smith, T.C. Forceps	208
Micro Surgery Set	182	Potts-Smith, T.C. Needle Holder	208
Micro-Adson, Tweezers	151	Probes	82-85,91,94
Micro-Friedman, Rongeurs	178		
Middledorpf Retractor	162	Q	
Miller, Articulating Forceps	147	Quinby, Scissors	183
Miller, Bone Files	130		



Alphabetical Index

R

Ragnell, T.C. Scissors	206
Retainers, Bands	146
Reynolds, Pliers	169,174
Root Planning Curettes	115
Root splinter forceps	35
Roux, Retractor	162
Rubber Dam Clamps	148
Rubber Dam Holder	147
Rule, Curette	110
Russian, Tissue Forceps	158
Ryder, T.C. Needle Holder	210
Ryder-Vascular, T.C. Needle Holder	210

S

Sarot, T.C. Needle Holder	210
Scalers	75-79
Scalpel Handles	71
Schwarz, Pliers	168,175
Schluger, File	114
Seldin, Elevator	50,55,67
Select, Tweezers	151
Semken, T.C. Forceps	207
Semkin, Tissue Forceps	158
Senn, Tissue Retractor	164
Separating Pliers	166
Sims, T.C. Scissors	205
Spatulas	123
Spencer, Scissors	186
Spencer-Wells, Forceps	157
Spreaders	87
Split Chisels,	128
Spring Bow Divider	143
Standard, T.C. Scissors	201
Standard, Tweezers	151
Steiner, Pliers	166
Sterilizing & Lab Instruments	156
Sterilizing Forceps,	163
Stevens, Needle Holder	181
Stevens, Scissors	183
Stille, Scissors	185
Stratte, T.C. Needle Holder	210
Strip Holder Clips	146
Syringes	150
Suction Tubes,	140,142
Sugarman, File	114

T

Toennis, Wire Cutting Pliers T.C.	213
-----------------------------------	-----

Toennis-Adson, Scissors	184
Toennis, Tissue Retractor	164
Towel Clamps, Napkin Holders	159
Tweed, Pliers	168
Telescope, Crown Plier	136
Traymann, Crown Remover	128

U

Universal, T.C. Scissors	207
Universal, Pliers	174
Universal, Elevator	135
Utility Plier	165

V

Vernier, Measuring Instruments	143
Vernier Gauge	143

W

Wakefield, Bone Chisels	132
Waldron, Pliers	174
Waldsachs, Pliers	174
Wangensteen, T.C. Forceps	208
Warwick-James, Elevator	62
Waugh, Tweezers	151
Wax & Modeling Carvers	120
Wax & Plaster Knives	127
Wax Carvers	101
Wax, Porcelain Instruments	118,119,121
Webster, Needle Holder	180,209
Weingart, Utility Pliers	167
Weitlaner, Retractor	160
West, Elevator	50
White, Rubber Dam Instrument	147
Wieder, Tongue Depressor	160
Winter, Elevator	65,69
Wire & Clasp Bending Pliers	170
Wire Bending Pliers	166
West, Elevator	50
Wire Cutter	165
Woodson,	98

Y

Young, Pliers	168,174
---------------	---------

Z

Zuricher, Measuring Instrument	143
Zuricher, Gauge	143



REAL
ENTERPRISES
QUALITY FIRST
Since 1908



No. 46 Kotli Lohran Baqar Por District Sialkot 51310 Pakistan



00923466700574



info@realenterprisesmed.com



www.realenterprisesmed.com

